

Keeler Applanation Tonometer (KAT)

Instructions for use



Contents

- 1. Introduction**
 - 1.1 Brief description of the instrument
 - 1.2 Intended use / purpose of instrument
 - 1.3 How the intraocular pressure is measured
 - 1.4 Advantages of using a Goldmann Tonometer
- 2. Symbols used**
- 3. Safety**
 - 3.1 Standards applied
 - 3.2 Warnings and Cautions
- 4. Cleaning and disinfection instruction**
 - 4.1 Cleaning Tonometer body
 - 4.2 Disinfecting the Tonometer prisms
- 5. Tonometer Prism field check**
- 6. Name of components of R type and T type KAT**
- 7. Measurement procedure**
 - 7.1 Installation on to the Slit Lamp
 - 7.1.1 Keeler Applanation Tonometer (T type)
 - 7.1.2 Applanation Tonometer 'Keeler Fixed' (R type)
 - 7.2 Preparing the patient
 - 7.3 Preparing the Slit Lamp instrument for examinations at 10 x magnification
 - 7.4 Using the instrument/ taking a measurement
 - 7.4.1 Instructions to the patient
 - 7.4.2 Taking the measurement
- 8. Problem solving**
- 9. General information and suggestions concerning measurement**
- 10. Astigmatism**
- 11. Routine instrument maintenance**
 - 11.1 Check procedure with the measurement drum set to 0
 - 11.2 Check procedure with measurement drum set to 2
 - 11.3 Check procedure with the calibration arm set to 6
- 12. Servicing and calibration**
- 13. Specifications**
 - 13.1 Transport, storage and working conditions
 - 13.2 Technical specifications
- 14. Accessories and warranty**
- 15. Contact information**

Please click on the contents to go straight to your chosen section or navigate by using the 'Next' and 'Back' buttons to the right. Clicking on 'Home' will bring you back to this page.

1. Introduction

Thank you for choosing this Keeler Applanation Tonometer (KAT).

Please read this manual carefully before using your KAT. This will ensure the safety of the patient and your confidence in the measurements it provides. This manual should be stored safely for future use.

1.1 Brief description of the instrument

The Keeler Applanation Tonometer operates according to the "Goldmann method", by measuring intraocular pressure from the force required to flatten (applanate) a constant area (3.06mm) of the cornea. A special disinfected (or single use) prism is mounted on the Tonometer head and then placed against the cornea.

The examiner, using a slit lamp biomicroscope at 10x magnification, with a blue filter views two fluorescing green semi circles. The force applied to the Tonometer head is then adjusted using the dial until the inner edges of these green semi-circles meet.

Because physical contact with the cornea takes place it is necessary to apply to the patients cornea a suitable topical anaesthetic.

1.2 Intended use / purpose of instrument

The Keeler Applanation Tonometer is indicated for measuring intraocular pressure to aid in the screening and diagnosis of glaucoma.

The Keeler Applanation Tonometer (KAT) is an accessory item for most 'Tower Illumination' type of Slit Lamps and thanks to its versatility, the KAT Tonometer can be mounted on and used with slit lamps produced by many manufacturers.

The KAT should be used only by trained personnel. USA Federal law restricts this device to sale by or order of a physician.

The manufacturer declines any and all responsibility and warranty coverage should the instrument be tampered with in any manner or should routine maintenance be omitted or performed in manners not in accordance with these manufacturer's instructions.



R type (fixed) KAT on Slit Lamp

1. Introduction

1.3 How the intraocular pressure is measured

The cornea is flattened by an acrylic measuring prism on a ring support at the end of the Tonometer sensor arm assembly. It is flat with smooth or rounded margins to avoid any damage to the cornea.

The measuring prism is brought into contact with the patient's eye by moving the slit lamp forward. The measurement drum is then turned to increase the pressure on the eye until a continuous, uniform applanated surface 3.06 mm in diameter (7,354 mm² area) is obtained. The doubling prism divides the image and presents the two opposing semicircular halves at 3.06mm (see section 7.4.2 Measurement procedure for further details).

Position of the measurement drum	Force mN	Pressure	
		kPa	mmHg
1	9.81	1.33	10
2	19.62	2.66	20
3	29.43	39.9	30
4	39.24	53.2	40
5	49.05	66.5	50
6	58.86	79.8	60
7	68.67	93.1	70
8	78.48	10.64	80

Relationship between the pressure of the measurement drum and the force and pressure on the applanated surface.

The intra-ocular pressure, expressed in mmHg, is calculated by multiplying the drum measurement by ten (for conversion from one unit to another).

1.4 Advantages of using a Goldmann Type Tonometer

- Intraocular pressure can be measured during routine examination with the Slit Lamp.
- The standard deviation among single measurements is approximately $\leq 0,5$ mmHg.
- The value is expressed in mmHg and is read directly on the instrument.
- Scleral rigidity need not be taken into consideration because the small volume moved (0,56 mm³) increases intra-ocular pressure by only about 2.5%.
- There are no difficulties as regard standardisation and calibration.

2. Symbols used



Read user instructions for Warnings, Cautions and additional information



The CE mark on this product indicates it has been tested to and conforms with the provisions noted within the 93/42/EEC Medical Device Directive



Consult instructions for use



Manufacturers name and address



Keep dry



Fragile



Material suitable for recycling

3. Safety

Use this instrument only in strict accordance with the instructions contained in this manual.

3.1 Standards applied

The Keeler Applanation Tonometer is designated as Class I non-invasive measuring device under EC Directive 93/42/EEC for medical equipment products.

The CE mark on this product indicates it has been tested to and conforms to the provisions noted within the 93/42/EEC Medical Device Directive.

It also complies with **ISO 15004-1:2006** ophthalmic instruments-Fundamental requirements and test methods and **BS EN ISO 14971:2007** Medical Devices - Application of Risk Management to Medical Devices.

Classification

CE Regulation 93/42 EEC: Class 1m (Measuring function)

FDA: Class II

3. Safety

3.2 Warnings and Cautions



- The instrument should be used only by qualified and specially trained personnel.
- The owner of the instrument is responsible for training personnel in its correct use.
- Accuracy of applanation IOP measurements is known to be affected by variations and changes in corneal rigidity due to differences in corneal thickness, intrinsic structural factors or corneal refractive surgery. It is recommended that these factors are considered during IOP measurement.
- Do not use the product if visibly damaged and periodically inspect for signs of damage or misuse.
- The contact surface of this prism should be checked before each use for damage and discarded if damage is found.
- We recommend that the prism is not used when it becomes more than two years of age as, after this time it is possible that body or sterilising fluids may seep inside leading to possible sterility and cross contamination issues.
- Only decontaminate / clean in accordance with method given in Cleaning Section 4 of this instruction manual.
- Use only cloths dampened with water to clean the Applanation Tonometer body. Do not use corrosive products or alcohol.
- Keeler Applanation Tonometers should be serviced and calibrated annually. Any servicing or repairs/modifications should only be carried out by Keeler Ltd. or by suitably trained and authorised distributors. The manufacturer declines any and all responsibility for loss and/or damages resulting from unauthorised repairs; furthermore, any such actions will invalidate the warranty.
- Never use the instrument if the ambient temperature, atmospheric pressure, and/or relative humidity are outside the limits specified in this manual.
- Should the instrument suffer shocks (for example, should it accidentally fall), follow the check procedure outlined in the "Calibrations" section 12 ; if necessary, return the instrument to the manufacturer for repair.
- Use only the listed accessories in conjunction with the instrument; use said accessories only in accordance with the procedures set forth in the instruction manuals.
- Always carefully observe the safety rules and other precautions published herein.

4. Cleaning and disinfection instruction

4.1 Cleaning Tonometer body

- Only manual non-immersion cleaning as described should be used for this instrument.
- Wipe the external surface with a clean absorbent, non-shedding cloth dampened with a water / detergent solution (2% detergent by volume) or water / isopropyl alcohol solution (70% IPA by volume).
- Use caution to ensure cloth is not saturated with solution.
- Surfaces must be carefully hand-dried using a clean non-shedding cloth.
- Safely dispose of used cleaning materials.

4. Cleaning and disinfection instruction

4.2 Disinfecting the Tonometer prisms

Always disinfect the Tonometer prisms before use. Hand hygiene must be considered to prevent any contamination.

- 1 Carefully remove the Tonometer prism from the prism holder.

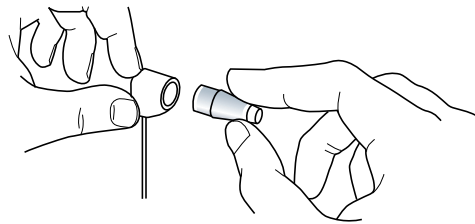

- 2 Wash the Tonometer prism under cold running water for approximately 1 minute, to ensure Tonometer prism is physically clean before exposed to disinfection process.

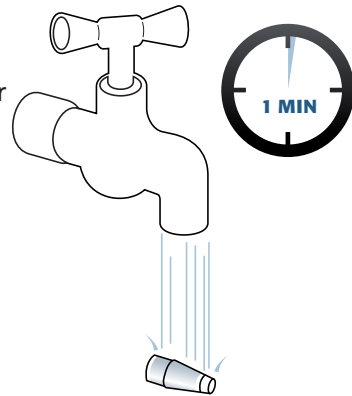

- 3 Immerse the Tonometer prism in the disinfectant fluid. Types of disinfectant fluid vary.

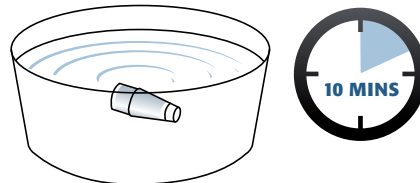

Please follow disinfectant solution guidelines for instructions, concentration and time of immersion. (For example: Pantasept - 3% aqueous solution for 10 minutes, Hydrogen Peroxide 3% aqueous solution for 10 minutes, Sodium Hypochlorite, 10% aqueous solution for 10 minutes etc.).

- 4 Rinse the disinfectant from the prism in running water for between 10 and 30 minutes.

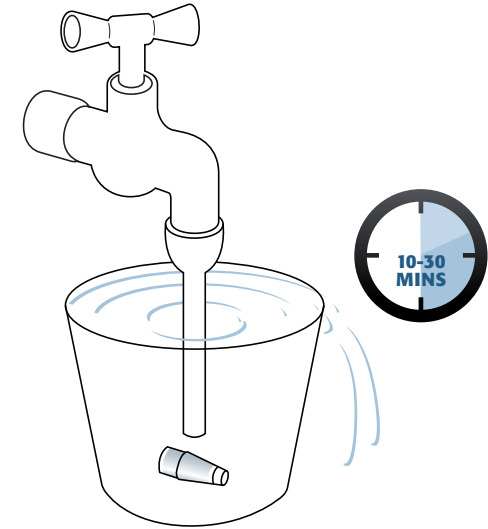

- 5 Dry the disinfected Tonometer prism with a clean soft cloth.

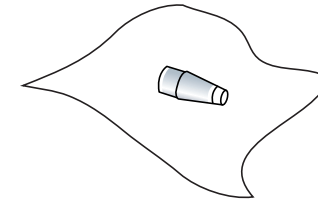

- 6 Store the Tonometer prism in a suitable container ready for use.

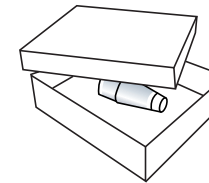

Safely dispose of the disinfectant fluids used.



Do not disinfect using the following:

Alcohol, Acetone, UV radiation, Sterilisation, Immersion in fluid for more than one hour, Temperatures greater than 60°C

5. Tonometer Prism field check

Check Tonometer prism under Slit lamp and ensure there is no cracks/chips. Chemical used in diagnosis process (for example: Fluorescein) will get into the cracks and will show up if observed under slit lamp. Do not use it if there is any sign of crack or chip.

6. Name of components of R type and T type KAT

- 1. Control weight housing
- 2. Rotating measurement knob
- 3. Doubling prism
- 4. Measurement arm
- 5. Manufacturers data
- 6. T type mounting assembly
- 7. R type mounting assembly
- 8. Calibration arm assembly



R type KAT (fixed)
Part number: 2414-P-2040



T type KAT (take-away)
Part number: 2414-P-2030

7. Measurement procedure

7.1 Installation on to the Slit Lamp

Before installing the Tonometer on a Slit Lamp ensure that they are mutually suitable.

7.1.1 Keeler Applanation Tonometer (T type)

- Position the guide plate in the Tonometer/test bar support hole on the slit lamp.
- Lift Tonometer out of the packaging and assemble it by inserting the pin on its base into one of the two possible openings (for right or left eye) on the horizontal guide plate above the slit lamp axis. These positions are related to the microscope optics and observation can be made either through the right or the left eye-piece.
- The Tonometer will slip easily onto the support plate; stability is assured by the locking pins.
- To obtain an image as clear and as free of reflexes as possible, the angle between the illumination and the microscope should be about 60° and the slit diaphragm should be fully opened.
- When not in use the Tonometer should be removed from the Slit Lamp and placed securely back in the packaging or a suitable location.



7. Measurement procedure

7.1.2 Applanation Tonometer 'Keeler Fixed' (R type)

This instrument is for those who wish the Tonometer to remain permanently on the slit lamp.

- Mount the plate for the Tonometer onto the microscope body using the securing screw.
- Then mount the Tonometer mount onto the mounting post.
- Swing the Tonometer forward in front of the microscope for examination. A notch position ensures exact centring of the prism with the left objective.
- To obtain an image as clear and as free of reflexes as possible, the angle between the illumination and the microscope should be about 60° and the slit diaphragm should be fully opened.
- When not in use the instrument is swung around and secured in a notch position to the right of the microscope.



7. Measurement procedure

7.2 Preparing the patient

- Use an appropriate topical anaesthetic to numb the cornea.
- Place a strip of fluorescein-soaked paper near the outer canthus in the lower conjunctival sac. After a few seconds the lacrimal fluid will be colored and the paper may be removed. When using drops, we recommend a 0.5% solution of fluorescein sodium. If using a 1% or 2% solution, use a glass rod to introduce a small quantity of liquid into the conjunctival sac.
- Seat the patient at the Slit Lamp and place his chin on the chinrest and ensure the forehead touches the forehead rest.
- Adjust the chinrest height so that the patients eye is at the correct height (most Slit lamps have a marker on the chinrest pole for correct height adjustment).

7. Measurement procedure

7.3 Preparing the Slit Lamp instrument for examinations at 10 x magnification

- Before beginning measurement, check that the eyepieces of Slit Lamp are correctly focused.
- Set the brightness control of the instrument to position a low intensity.
- Set the illumination angle of the Slit Lamp to be approximately 60° to minimise unwanted reflections.
- Insert the blue filter on the slit lamp beam path and fully open the slit diaphragm.
- Clean the doubling prism with Pantasept fluid at between 0.5% and 3.0% concentration or with a similar disinfectant solution that is innocuous to organic glass ("plexiglass"). After cleaning, rinse the doubling prisms in distilled water and allow to dry. Full instructions on cleaning the prism is covered earlier in this manual.

- Place the doubling prism on into the holder and align the 'zero mark' with the white alignment line on the prism holder, this ensures the mires have a horizontal split.
- Insert the measurement arm so that the measurement head and microscope optics axes are convergent.
- Rotate the measurement drum to position 1.



7. Measurement procedure

7.4 Using the instrument/ taking a measurement

7.4.1 Instructions to the patient

- The patient's head must be firmly positioned on the chin rest and the forehead rest. If necessary, a band may be used to hold the head still.
- Ask the patient to look straight ahead. If necessary, use a fixation target to keep the eyes still.
- We recommend occasionally reminding the patient during the examination, to keep his/her eyes wide open. If necessary, the examiner may use the tips of his fingers to hold the lids open, taking care not to exert pressure on the eye.
- When elevating the lids, the angle between the microscope and the lighting unit must be reduced to about 10° , so that the light beam passes through the body of the prism. In this position it should be possible to obtain an image with no reflections.
- Immediately before measurement, ask the patient to close his/her eyes for a few seconds, in order to ensure that the cornea be sufficiently wetted by the lacrimal fluid containing the fluorescein solution.

7. Measurement procedure

7.4.2 Taking the measurement

- Move the slit lamp forward to bring the measuring prism into contact with the centre of the cornea in the area above the pupil. The limbus will be illuminated with a bluish light. The examiner will be able to better directly observe this phenomenon from the opposite side.
- As soon as the corneal limbus is correctly illuminated, immediately stop all forward movement of the slit lamp.
- After contact is established, observe the cornea through the microscope. With the measurement drum set to position 1, the two semicircular fluorescein rings (which will vary in size according to ocular pressure) will pulse rhythmically when the Tonometer is in the correct position for measurement.
- Use the Slit Lamp joystick control to make any corrections needed until the applanated surface is observed as two semicircular surfaces of equal area at the Centre of the field of vision. (Figure 1). Small adjustments downward made with the joystick will have no effect on the sizes of the semicircular images.

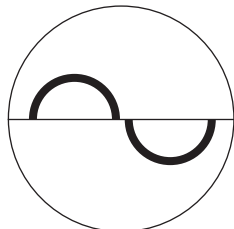

Figure 1: Semicircular images at the Centre of the field of vision.

- Increase applanation pressure by rotating the Tonometer measurement drum until the margins of the fluorescein rings touch and the cross as the eye pulses (Figure 2). The width of the fluorescein rings around the contact position of the measuring prism should be equal to about 1/10 of the diameter of the applanation surface (0,3 mm).
- To read the scale, multiply the readings by a factor of ten (10). The result is the ocular pressure expressed in mmHg.

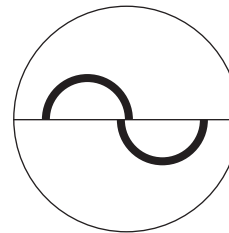
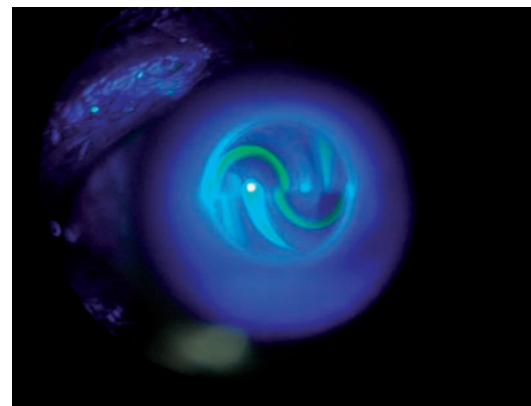
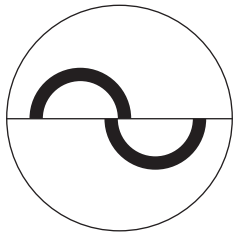

Figure 2: Correct Final Position



8. Problem solving

1. The fluorescein ring is too wide or too narrow



Cause:

The fluorescein semi-circles are too wide. The measuring prism was not dried after cleaning, or the eyelids came into contact with the measuring prism during measurement. The pressure reading is higher than the real intraocular pressure.

Correction:

Move the slit lamp back and dry the measuring prism with a wad of sterile cotton wool or lint free cloth.

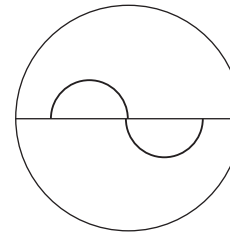

Cause:

The fluorescein semi-circles are too narrow. The lacrimal fluid has dried during prolonged measurement. The pressure reading is lower than real ocular pressure.

Correction:

Move the Slit Lamp back and ask the patient to close his/her eyes once or twice, then repeat the measurement procedure.

8. Problem solving

2. The measurement prism does not touch the cornea or too much force has been applied

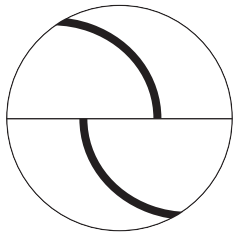

Cause:

If the patient pulls his/her head back even slightly, the pulses will become irregular and measuring prism contact with the eye will become intermittent. If the patient pulls his/her head even further back, the fluorescein semi-circles will completely disappear.

Correction:

If possible, use a band to hold the patient's head in place.

Cause:

If during measurement the slit lamp is moved forward toward the patient or the patient moves toward the slit lamp, the sensor arm will be pushed into contact with a stop spring. The applanation surface will be too large. The image will not change when the measurement drum is rotated.

Correction:

Retract the slit lamp until regular pulses and a correspondingly smaller applanation surface are obtained. This is the correct measurement position, in which variations in pressure will not cause immediate variations in the applanation surface.

8. Problem solving

3. The two semicircles are not central in the field of vision

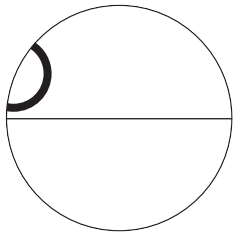

Correction:

Using the joystick, move the slit lamp up and to the left.

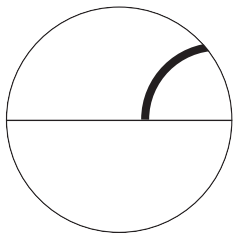
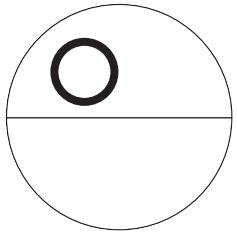

Cause:

The rings are too far to the right.

Correction:

Using the joystick, move the slit lamp to the right.

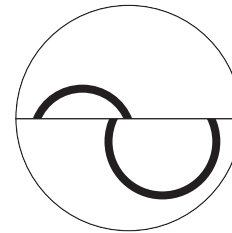

Cause:

The reading in this position is considerably higher than real ocular pressure.

Correction:

Using the slit lamp height adjustment mechanism, lower the slit lamp until the two fluorescein semi circles are equal in size. Measurement pressure will then be reduced.

8. Problem solving

4. The inside margins of the fluorescein rings are not aligned and touching

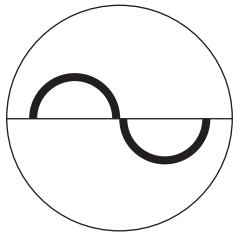

Cause:

The semi-circular images are well centred.
The outer margins are aligned but the inner margins are not.

Correction:

Increase pressure by rotating the measurement drum.

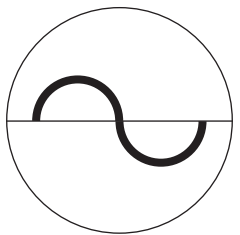

Cause:

In this case, the inner margins of one semicircle are aligned with the outer margins of the other.

Correction:

Increase pressure by rotating the measurement drum.

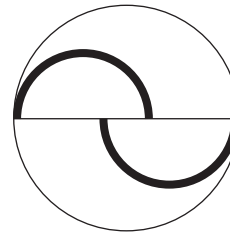

Cause:

Excessive pressure has been applied.

Correction:

Reduce pressure until the semicircular images come closer together and finally the inner margins align with each other, as shown in the last illustration.

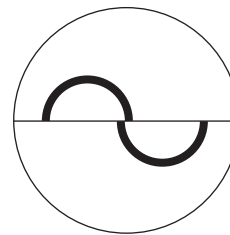

Correct final position

The inner margins of the fluorescein semicircular images are aligned and just touching each other.



9. General information and suggestions concerning measurement

IMPORTANT NOTE

Measurement must be performed as quickly as possible on each eye. Should epithelial drying be observed, we recommend the patients acuity and visual fields should be examined.

The pressure measurement procedure may be repeated several times. Nervous or anxious patients often have higher intra ocular pressure during the first measurement procedure.

It has been found that pressure decreases during the first few minutes of the procedure, when the patient realises that the tonometric examination does is not unpleasant. When correctly anaesthetised and with their eyes fully open, the patient will feel absolutely nothing. Therefore we recommend running a preliminary measurement procedure on each eye, the results of which need not be taken into consideration. After completing the preliminary procedure, run three measurement procedures on each eye. These readings will be correct if the pressure has stabilised. When the measurement procedures are performed correctly, the results of the subsequent measurements will vary by only about 0,5 mmHg.

When the measurement procedure for one eye is prolonged excessively, drying phenomena will occur on the corneal epithelium of both eyes.

A ring of fluorescent deposits will form around the cornea contact surface and around the measuring prism on the eye being examined. The other eye will show fluorescent dry areas, resembling a map, which will hinder and make measurement unreliable.

The eye will rapidly recover from any corneal dryness without the need for any treatment, visual acuity may be temporarily affected by fine epithelial defects.

10. Astigmatism

If the cornea is spherical, measurements may be made along any meridian, but it is usual to measure along the horizontal 0° meridian. This is not the case when measurements are made on eyes affected by corneal astigmatism of greater than 3 dioptres, since the flattened areas will not be circular but elliptical.

It has been calculated that in cases of more severe corneal astigmatism a surface area of 7,354 mm² (∅ 3,06 mm) must be applanated; in this case the measuring prism forms an angle of 43° to the meridian of maximum radius.



For example:

For corneal astigmatism of 6.5mm / 30° = 52.0 dioptres / 30° and 8.5mm / 120° = 40.0 diopter / 120°, the 120° prism value will be aligned with the 43° "A" mark on the prism support.

For corneal astigmatism of 8.5mm / 30° = 40.0 dioptres / 30° and 6.5mm / 120° = 52 dioptres / 120°, the 30° prism value will be aligned with the 43° "A" mark. In other words, align the axial position of the major radius (that is, the axis of a negative cylinder) with the prism value at the "A" mark on the prism support.

11. Routine instrument maintenance

Keeler recommends this routine maintenance be carried out by user frequently to ensure safe and accurate measurement. In the event of the device being outside of the calibration tolerances, it is important to send the device back to Keeler Ltd. Windsor for repair and re calibration.

11.1 Check procedure with the measurement drum set to 0

Attach the calibration arm assembly.

Calibration Position – 0.05:

Rotate the measurement drum zero calibration downward by the width of one calibration mark (see Figure 3). When the sensor arm is in the free movement zone, it should move against the stop in the examiner’s direction.

Calibration Position + 0.05:

Rotate the measurement drum zero calibration upward by the width of one calibration mark (see figure 4). When the sensor arm is in the free movement zone, it should move against the stop in the patient’s direction.

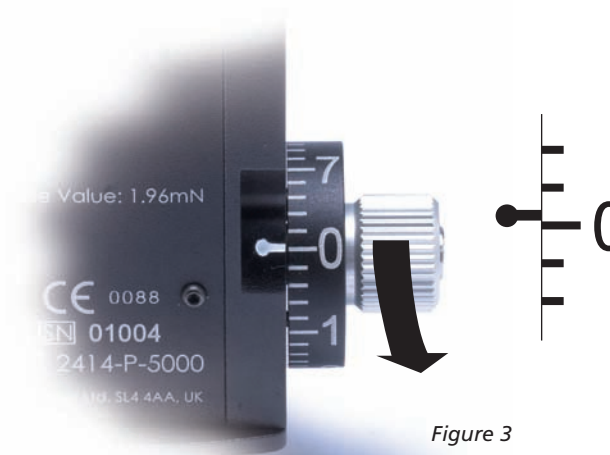

Figure 3

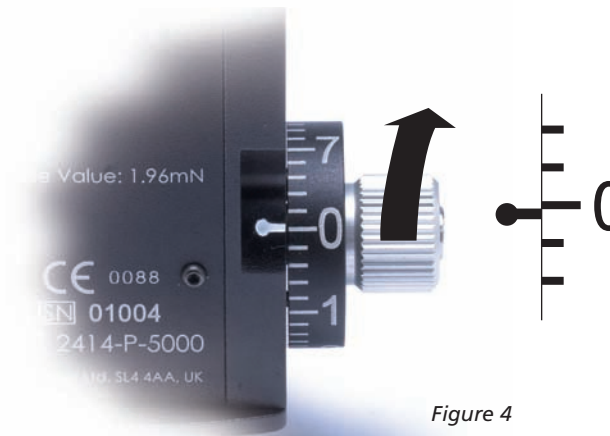

Figure 4

11. Routine Instrument Maintenance

11.2 Check procedure with measurement drum set to 2



This is the most important check procedure, since measurement of intraocular pressure in this area is highly significant. We recommend running this check daily.

This check is made using the calibration arm (Figure 5). The arm is engraved with 5 circles. The Centre circle corresponds to drum position 0, the two immediately to the left and right to position 2, and the outermost two to position 6.

Slide the bar in the support until one of the position 2 marks on the weight is located exactly at the reference mark of the weight support. With the weight of the bar towards the examiner the +2 check can be made, with the weight of the bar towards the patient the -2 check can be made.

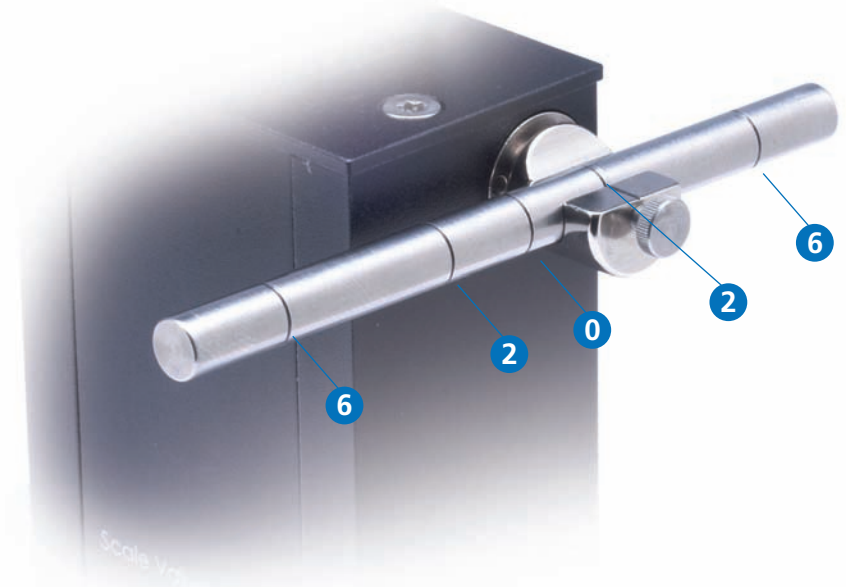

Figure 5: Control Weight

Continued on page 26

11. Routine Instrument Maintenance

11.2 Check procedure with measurement drum set to 2 contd.

When the drum position is 1.95 and/or 2.05, the sensor arm should move from the free movement area to the corresponding stop.

Calibration Position – 1.95:

Rotate the measurement drum 2 calibration downward by the width of one calibration mark (see Figure 6). When the sensor arm is in the free movement zone, it should move against the stop in the examiner's direction.

Calibration Position + 2.05:

Rotate the measurement drum 2 calibration upward by the width of one calibration mark (see figure 7) When the sensor arm is in the free movement zone, it should move against the stop in the patient's direction.

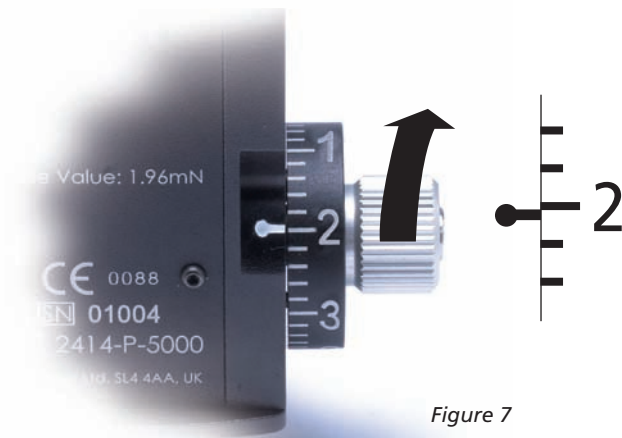
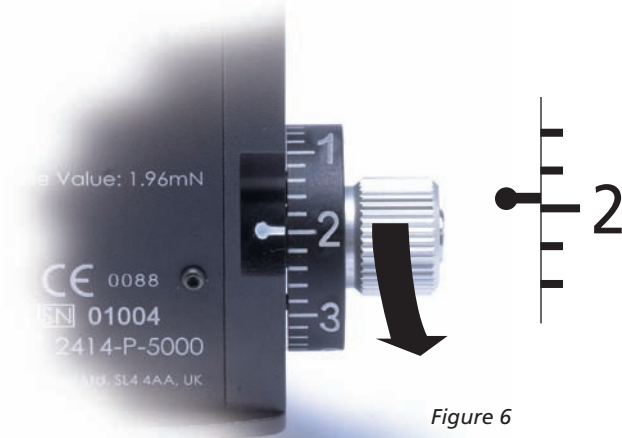

11. Routine Instrument Maintenance

11.3 Check procedure with the calibration arm set to 6

The Tonometer check procedure with a scale 6 calibration is very similar to those described above. The checkpoints are 5.9 and/or 6.1. Rotate the "6" calibration mark on the drum through $\frac{1}{2}$ interval downward and/or upward, respectively, with respect to the index mark.

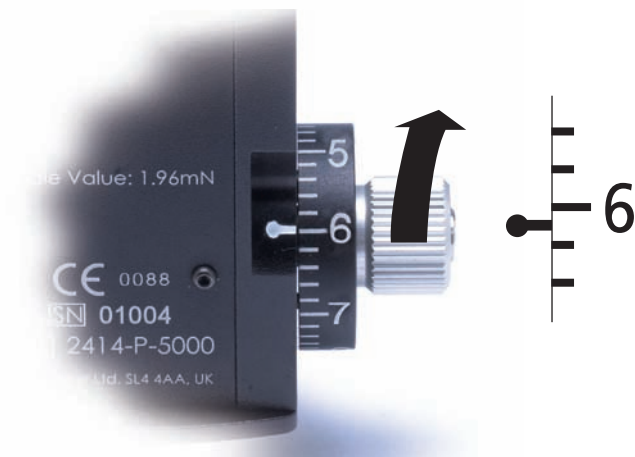

12. Servicing and calibration

Keeler recommends annual calibration of the instrument. This must be performed by an authorised service centre or distributor.

There are no user serviceable parts in this instrument. Service manuals will be available to authorised Keeler service centres and Keeler trained service personnel.

13. Specifications

13.1 Transport, storage and working conditions

The following ambient condition limits are recommended for the Keeler Applanation Tonometer, for transport and storage it is recommended that the Tonometer is kept in its original manufacturers packaging.

Before use the Tonometer should be allowed to adjust to the ambient room temperature for several hours.

Ambient Conditions

Transportation	Temperature	-40°C to +70°C
	Air Pressure	500 hPa to 1060 hPa
	Relative humidity	10% to 95%
Storage	Temperature	-10°C to +55°C
	Air Pressure	700 hPa to 1060 hPa
	Relative humidity	10% to 95%
Storage	Temperature	+10°C to +35°C
	Air Pressure	800 hPa to 1060 hPa
	Relative humidity	30% to 75%

13. Specifications

13.2 Technical specifications

Measurement force	By leverage weight
Installation:	
Keeler T type: for Haag Streit type illumination systems	Fitted to the guide plate on the optical axis for the microscope and illumination unit arm
Keeler R type: for some Zeiss type and Haag Streit type illumination systems	Mountable on post on microscope
Installation	Assembled on the guide plate on the slit lamp arm
Measurement range	0 - 80 mmHg (0 – 10.64 kPa)
Approximation of the impact force on the measuring prism for a 0 to 58,84 mN measurement range	Standard divergence: $0.49 \text{ mN} \leq 3s \leq 1.5 \% \text{ of nominal value}$
Operating temperature range	From 10°C to 35°C
Measurement uncertainty	$\leq 0.49 \text{ mN}$
Net weight	
Keeler T type	0.48 kg (without accessories)
Keeler R type	0.82 kg (without accessories)
Part Numbers	
Keeler T type	2414-P-2030
Keeler R type	2414-P-2040

14. Accessories and warranty

14.1 Accessories

Tonometer doubling prism	Part Number 2414-P-5001
Calibration arm assembly	Part Number 2414-P-5005
T type guide plate	Part Number 2414-P-5032
R type post	Part Number 2414-P-5042
Luxury carrying case	Part Number 3414-P-7000



Tonometer doubling prism



Calibration arm assembly

14.2 Product warranty

2 years against faulty workmanship, Materials and labour.

Warranty will be conditional on routine maintenance and will not cover calibration or mechanical issues caused as a result of lack of maintenance, poor use, incorrect transport or inappropriate storage conditions.



T type guide plate



R type post



Luxury carrying case

15. Contact information

Manufacturer

Keeler Limited
Clewer Hill Road
Windsor
Berkshire
SL4 4AA

Freephone: 0800 521251

Tel: +44 (0) 1753 857177

Fax: +44 (0) 1753 827145