



Hand Held Auto Refractometer

Retinomax Screen

Instructions

November 2018

D054-E



CAUTION: Please read this instruction manual before using the instrument.

This instruction manual is intended for users of the Retinomax Screen.

It includes instructions on how to use the instrument, safety handling precautions, and specifications.

These instruments conform to the Japanese Industrial Standards (JIS) as well as the standards of the International Electrotechnical Commission (IEC).

Before using the instrument be sure to read the instructions carefully, and fully understand the operation procedures and safety instructions to ensure correct usage. Also, please keep this manual near the main unit so that you can refer to it whenever necessary.

If you have any questions or comments, please do not hesitate to contact the dealer from whom you purchased the instrument.

- No part of this manual may be reproduced or transmitted without permission.
- The information in this manual is subject to change without prior notice.

CONTENTS

■ Handling Precautions - Please first read for safety purposes	5
■ EMC (Electromagnetic Compatibility)	11
1. Overview	16
1-1 Instrument Overview, Components and Options	16
1-2 Instrument Classification	17
1-3 Symbols on the Instrument	18
1-4 Labels and Marks.....	20
2. Name of Parts	24
2-1 Main Unit.....	24
2-2 Operation Panel	25
2-3 Station.....	27
2-4 Printer.....	28
3. Setup.....	30
3-1 Attaching/Detaching the Strap	30
3-2 Installing and Removing the Battery Pack	30
3-2-1 Main Unit.....	30
3-2-2 Printer	31
3-3 Setting Up the Instrument	31
3-4 Charging the Battery Pack	32
3-4-1 Automatic Charging of the Main Unit	33
3-4-2 Automatic Charging of the Printer.....	34
3-4-3 Charging a Spare Battery Pack	34
4. Measurement	35
4-1 Power on.....	36
4-1-1 Opening Screen	36
4-1-2 Measurement Screen.....	36
4-1-3 Setting Confirmation	38
4-1-4 Measuring the Model Eye	41
4-2 Preparation for Patient	43
4-2-1 Prepare the Forehead Rest	43
4-2-2 Positioning the Measurement Eye	43
4-2-3 Before the Measurement	44
4-3 Measurement Modes and Start Measuring	45
4-3-1 Automatic Measurement Mode (AUTO, AUTO2).....	46
4-3-2 Continuous Measurement Mode (CONT)	50
4-3-3 CHILD/QUICK Mode.....	51

4-4	Various Functions	54
4-4-1	Pupil Diameter Measurement Function.....	54
4-4-2	Alignment Direction Indication Function.....	56
4-4-3	Focus Assist Function.....	57
4-4-4	Astigmatic Axis Correction Function	59
4-4-5	AUTO QUICK Mode.....	63
4-4-6	Retroillumination Mode	65
4-4-7	Storing Data	66
4-5	Printing	69
4-5-1	Printing Procedure	69
4-5-2	Printing Examples	71
4-5-3	Cutting off the Printer Paper	72
4-5-4	Using Multiple Printers	73
4-5-5	Change Setting by DIP Switch	74
4-6	Power off.....	74
4-7	The Other	75
4-7-1	For Proper Measurement.....	75
4-7-2	Auto Fogging.....	77
4-7-3	Representative Value.....	79
4-7-4	REF Confidence Value	79
4-7-5	Standby Mode and Auto Power off	80
4-7-6	Measurement of IOL Eyes	80
4-7-7	If Measured Values are not Obtained	80
5.	Setting Up the Instrument.....	82
5-1	Measurement Setup [MEASURE].....	83
5-2	OUTPUT Screen [OUTPUT]	84
5-2-1	Output Setting [OUTPUT SETTING].....	85
5-2-2	Output Format [OUTPUT FORMAT].....	86
5-2-3	Output Format of CONT Measurement [CONT FORMAT]	87
5-3	MEMORY Screen [MEMORY]	88
5-4	CHILD Mode Screen [CHILD]	90
5-5	OTHER Setting [OTHER].....	91
5-6	CLOCK Screen [CLOCK].....	92
5-7	POWER OPTION Screen [POWER OPTION]	93
5-8	Patient Number Setup [PATIENT No]	94
5-9	MESSAGE Screen [MESSAGE]	95
5-10	INITIALIZING Screen [INITIAL].....	96

5-11	VERSION Confirmation [VERSION]	97
6.	Connecting to External Instruments	98
6-1	Wireless Transmission to the Remote Vision RV-II	98
6-2	Connecting to Computer via USB	98
7.	Maintenance	99
7-1	Checking the Measurement Accuracy	99
7-2	Replacing the Print Roll	99
7-3	Replacing the Fuses	100
7-4	Cleaning the Forehead Rest	101
7-5	Cleaning the Measurement Window	101
7-6	Cleaning Model Eye	101
7-7	Cleaning Appearance	101
7-8	List of Consumable and Maintenance Parts	102
7-9	Lifetime of the Instrument	102
8.	Troubleshooting	103
8-1	Main Unit	103
8-2	Station	105
8-3	Printer	106
9.	Main Specifications	108

■ Handling Precautions - Please first read for safety purposes

<Caution Symbols Used in This Manual>

Righton products are manufactured with full attention to safety. However, these instruments can cause personal injury or equipment damage if used improperly or if the instructions are ignored. For your own safety, read this instruction manual carefully and thoroughly before using the instrument. Do not discard this manual, but keep it handy for easy reference.

This manual uses the following symbols to draw your attention to “important safety instructions”. Be sure to follow the instructions marked with these symbols.

Symbol

Meaning



CAUTION: Indicates a potentially hazardous situation which, if not avoided, could result in injury or damage to the surrounding equipment.



CAUTION 1. Intended product use

- Retinomax Screen is only intended to be used for measuring refractive power and pupil diameter. Do not use it for any other purpose.



CAUTION 2. Do not disassemble

- Never attempt to disassemble the product as it could cause a serious electric shock or equipment damage.



CAUTION 3. Measuring operation

- When moving the main unit toward the patient or laterally in front of the patient, use care to avoid hitting the patient's face.

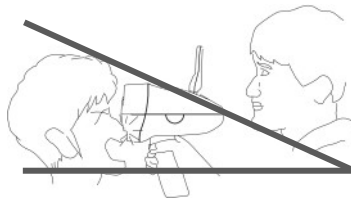

- Do not measure under environment if there are many people or strong lights around the patient where disturbing measurement, it may cause failure of measurement.



CAUTION 4. Installation and transport

- Do not place the instrument and the peripheral equipment (PC, monitor) on an unstable location, such as a shaky table or inclined surface. It could be dropped or fall and cause injury.
- Hold the main unit using the grip. Do not hold it with the LCD or forehead rest.
- Install the unit at place where easy to plug and unplug the electric outlet.
- Place the station and the printer in a well-ventilated location. Do not place thick cloth or paper under the station or the printer, as it may prevent the release of heat during battery charging. Heat will accumulate internally, leading to the danger of fire or failure.
- The operating environment: Temperature 10°C to 35°C, relative humidity 30% to 85% (no condensation), atmospheric pressure 800-1060 hPa.
- This instrument does not meet the temperature requirements of ISO 15004-1 for using. Do not use this instrument in conditions where the temperature may rise above 35°C or fall below 10°C.
- Although the instrument is designed with dust protection, it should not be used in a dusty room.
- The best location for the instrument is a room equivalent to a semi-dark room. Do not expose the instrument to a bright window or illumination light.
- Measurement space requirement is as follows. Follow requirement of IEC60601-1 if other type of instruments will be used.

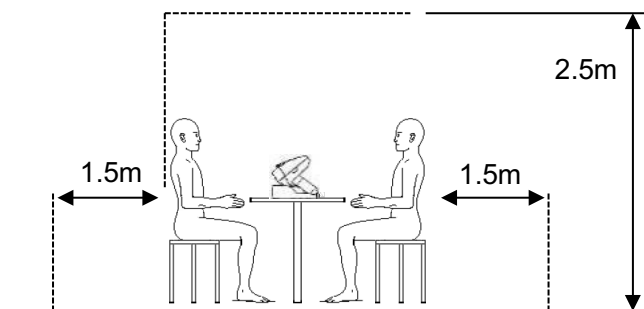
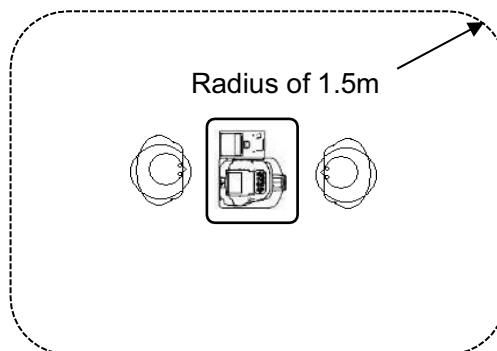

- The instrument conforms to the EMC standard (IEC60601-1-2:2014), but discharges weak radio waves. If the instrument in operation interferes with other equipment, such as a TV or radio, take appropriate action, such as increasing the distance between the instruments or changing each direction.

- This instrument is not waterproof. It should not be used or placed in a place where it can be exposed to liquid such as rainwater, beverages or chemicals.
- If dew condensation occurs, allow the dew to disappear before using the instrument.
- When transporting the instrument, protect against vibration and shock, preferably by placing the instrument in the optional carrying case or a packing box.



CAUTION 5. Other handling precautions

- Make sure that the power cord is not damaged, broken, machined, exposed to excessive force (bend, pull, or twist), or twisted with other cords. Do not put heavy objects on, or apply heat to, the power cord, as the cord can be severed, possibly leading to a fire or electric shock. If the power cord is damaged, replace it.
- If dust accumulates on the metal part of the power plug, pull out the power plug and remove the dust. Dust or dirt can cause contact failure of the power plug, resulting in a fire.
- Connect the instrument to a grounding-type receptacle outlet in a manner that meets the power supply specifications. Improper connections can affect the performance, or even cause failure, leakage, shock, or fire.
- Fully insert the power plug. Insufficient insertion can cause a fire.
- When replacing the fuse in the station, be sure to turn off the power switch and pull out the power cord. Be sure to use the designated fuse. Use of an undesignated fuse can lead to electric shock or fire.
Designated fuse: Littelfuse's time-lag fuse, $\phi 5 \times 20$ mm
250 V, 1.6 AH (021501.6XP)
- Never short-circuit the battery charging contacts of the main unit, the station, or the printer.
- Do not expose the connectors or battery charging contacts to your body or metal objects. If a contact is dirty, turn the power off and wipe the contact off with a dry, soft cloth.
- If contacts become dirty, wipe with a dry, soft cloth after turning off the power.
- This product is precision optical equipment, containing a large number of electrical components. Handle with care, avoiding exposure to physical shock.
- Do not drop or bump the instrument. When handling the main unit, always use the supplied strap. Do not swing the main unit holding only the strap.
- If the instrument ceases to function, pull the power cord from the receptacle outlet, and without accessing the inside of the instrument, contact your dealer.
- Use the designated print roll. Use of an undesignated brand can lead to failure.
- Although the printer cutter is located at not accessible place by finger, caution when changing the paper roll.
- Use accessory cable enclosed with the unit. (See "1-1 Instrument Overview, Components and Options")

- Do not put any objects around power switch of the station or the printer to not disturbing emergency operation.

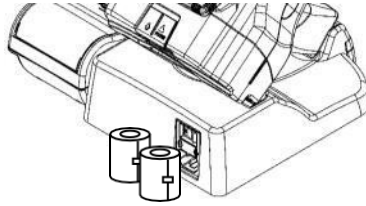

- Do not lean on the units.
- Please clean according to the specified method on the manual. If not follow, it may cause deterioration or damage to the unit. (See “7-4 Cleaning the Forehead Rest” to “7-7 Cleaning Appearance”)
- Clean the forehead rest for every patient, if not, it may cause cross infection.
- For repair or maintenance, wipe the outer cover with cloth with alcohol for sterilization.
- When the device is return for maintenance or repair, clean the surface of the device (especially, forehead rest) with a cloth dampened with rubbing alcohol for disinfections.
- Accessory equipment connected to the analog and digital interfaces must be certified according to the appropriate national standards. Furthermore, all configurations shall comply with the IEC 60601-1. Anyone who connects additional equipment to the signal input part or signal output part is responsible for making sure that the system complies with the requirements of the IEC 60601-1.
- The operator must not touch the external instrument connected with this equipment and the patient simultaneously. Electrical shock can result.
- If in doubt, consult the technical service department or your local representative.



CAUTION 6. Transportation / Storage

- The ambient conditions of transportation: Temperature -20°C to 60°C, relative humidity 10% to 95% (no condensation), atmospheric pressure 500-1060 hPa.
- The ambient conditions of storage in a packaged condition: Temperature -10°C to 45°C, relative humidity 10% to 85%(no condensation), atmospheric pressure 700-1060 hPa.
- This instrument does not meet the temperature requirements of ISO 15004-1 for storage. Do not store this instrument in conditions where the temperature may rise above 45°C or fall below -10°C.
- Select a storage area exposed to limited amounts of dust, free of vibration and shock.

- After use, turn off the power switch of the station and put on the dust cover.

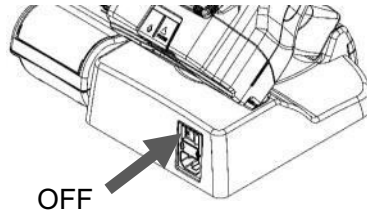

- If you plan to put the instrument out of service for a long time, pull the power cord out from the receptacle outlet. Also, remove the batteries from the main unit and keep them for later use. There is a danger of fire if the power cord is left in the receptacle outlet for a long time or the battery is left unremoved for a long time.
- Make sure that when the batteries are in storage, their contacts are not touched by metals, etc. If they are short-circuited to a metal, heating or even a fire can occur.
- When the measurement window stained by dust, nose oil, and fingerprint, effect the results of the measurement. Therefore, please keep clean on the surface of measurement window. (See “7-5 Cleaning the Measurement Window”)

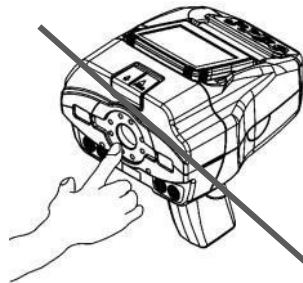

- To clean the measuring window, be careful not to make damage or broken of the window screen.
- Internal Battery

For clock function, lithium battery is equipped, and if the battery is out, date and time setting is not work properly. To change the battery, ask for your distributor.

 **CAUTION 7. Battery pack**

- You should use the RT-01XR battery pack, which uses our designated lithium ion battery. Use of any other battery pack voids the operation warranty.
- Carefully read the instructions shipped with the battery pack before using the battery pack.
- Never disassemble or modify the battery pack.
- To recharge the battery pack, always use the station or the printer.
- Never short-circuit the terminal of the battery pack. Otherwise, heating may occur, leading to burn injury or a fire. Also, keep metals (coins, paper clips, etc.) away from contact with the terminal area.
- Do not use the battery pack of this product with any other product.

- When charging the battery pack, do not place any cover over the main unit, the station, or the printer. If a cover is used, the heat generated in the main unit, the station, or the printer during charging may cause fire. In addition, the service life of the battery pack will be reduced by the additional load due to such a cover.
- Do not expose the battery pack to an intense heat source or flames. Explosion, electrolyte leakage, or fire can occur.
- Do not leave the battery pack in a sun-heated car with the windows closed, or in any location that may be exposed to intense sunlight.
- Do not let the battery pack be exposed to strong impact or drop it.
- If the metal terminals of the battery pack are dirty, wipe them off with a dry, soft cloth.
- If you plan to put the instrument out of service for a week or longer, take the battery packs out of the main unit and the printer.
- The battery pack is a consumable item. It can be recharged, but eventually wears out. When the battery pack is no longer usable, purchase a new one from your local dealer of the instrument.



CAUTION 8. Disposal instructions

- Follow local regulations concerning disposal and recycling. For lithium ion batteries and lithium primary battery, in particular, observe the specific disposal methods stipulated by your local government. We recommend entrusting disposal to a designated industrial waste disposal firm.
- When disposing packaging, sort them by material, and then follow the local regulations and plans concerning disposal and recycling.

Symbol for separate collection in European countries



Products bearing this symbol must be collected separately.

The following rule is applicable only to users in European countries.

This product is designated as an item to be collected separately at an appropriate spot. Do not dispose of it as household waste.

For further information, contact the retailer or the local authorities responsible for waste management.



CAUTION 9. Information of EMC (Electro Magnetic Compatibility)

1. Reorient or relocate the receiving device.
 2. Increase the distance to the device.
 3. Correct the device into an outlet on a circuit different from that to which the other device(s) are connected.
 4. Consult the manufacturer or field service technician for assistance.
- In installation and operation of the device, observe the following instructions about EMC (electromagnetic compatibility):
1. Do not use the device simultaneously with other electronic equipment to avoid electromagnetic interference with the operation of the device.
 2. Do not use the device near, on, or under other electronic equipment to avoid electromagnetic interference with the operation of the device.
 3. Do not use the device in the same room with other equipment such as life-support equipment, other equipment that has major effects on the life of the patient and results of treatment, or other measurement or treatment equipment that involves small electric current.
 4. Do not use the device simultaneously with portable and mobile radio frequency communication systems because it may have an adverse effect on operation of the device.
 5. Do not use cables and accessories that are not specified for the device because that may increase the emission of electromagnetic waves from the device or the system and decrease the immunity of the device to electromagnetic disturbance.

■ EMC (Electromagnetic Compatibility)

The Electromagnetic Compatibility Directive sets the essential requirements for electrical and electronic equipment that may disturb or even be disturbed by other equipment. The Retinomax Screen complies with these requirements as tabled below. Follow the guidance on the tables for use of the device in the electromagnetic environment.



WARNING: The use of this equipment adjacent to or stacked with other equipment should be avoided because it could result improper operation.

If such use is necessary, this equipment and the other equipment should be observed to verify that they are operating normally.



WARNING: The use of accessories and cables other than those specified or provided by the RIGHT MFG. CO., LTD. of Retinomax Screen could result in increased electromagnetic emissions or decreased electromagnetic immunity of Retinomax Screen and result in improper operation.

(A) : Environments for Retinomax Screen

This device is applied for use in professional healthcare facility environment and home healthcare environment.

— Doctor's offices, clinics, medical facilities, hospital, optician's offices, etc.

(B) List of cables, Length of cables

Model name	Model No.	Length
Power cord 100V area	DDB20207	3.0m
Power cord 120V area (Hospital grade)	DDB20201-UL	3.0m
Power cord 120V area	DDB20202	3.0m
Power cord 240V area	DDB20203	3.0m
Power cord 240V area (China)	DDC20209	3.0m

(C) EMC (IEC60601-1-2:2014)

(1) Emission guidance

Retinomax Screen is intended for use in the electromagnetic environment specified below. The customer or the user of the Retinomax Screen should assure that they are used in such an environment.

Emissions test	Basic EMC standard or test method*1
Conducted and radiated RF EMISSION	CISPRE 11 Group 1 ClassB
Harmonic EMISSION	IEC61000-3-2*2
Voltage fluctuations and flicker	IEC61000-3-3*2
*1: See "(A) Environments for Retinomax Screen" for information about the environments of INTENDED USE.	
*2: This test is not applicable in this environment unless the ME EQUIPMENT and ME SYSTEMS used there will be connected to the PUBLIC MAINS NETWORK and the power input is otherwise within the scope of the Basic EMC standard.	

(2) Immunity guidance

Retinomax Screen is intended for use in the electromagnetic environment specified below. The customer or the user of the Retinomax Screen should assure that they are used in such an environment.

• Enclosure port

Phenomenon	Basic EMC standard or test method	IMMUNITY TEST LEVELS
		Professional healthcare facility environment
Electrostatic discharge	IEC 61000-4-2	±8 kV contact ±2 kV, ±4 kV, ±8 kV, ±15 kV air
Radiated RF EM fields*1	IEC 61000-4-3	10V/m*6 80 MHz – 2,7 GHz*2 80% AM at 1 kHz*3
Proximity fields from RF wireless communications equipment	IEC 61000-4-3	See (C)-(3) Test Specifications for ENCLOSURE PORT IMMUNITY to RF wireless communications equipment
Rated power frequency magnetic fields**4*5	IEC 61000-4-8	30 A/m*7 50 Hz or 60 Hz
*1: The interface between the PATIENT physiological signal simulation, if used, and the ME EQUIPMENT or ME SYSTEM shall be located within 0,1 m of the vertical plane of the uniform field area in one orientation of the ME EQUIPMENT or ME SYSTEM.		
*2: ME EQUIPMENT and ME SYSTEMS that intentionally receive RF electromagnetic energy for the purpose of their operation shall be tested at the frequency of reception. Testing may be performed at other modulation frequencies identified by the RISK MANAGEMENT PROCESS. This test assesses the BASIC SAFETY and ESSENTIAL PERFORMANCE of an intentional receiver when an ambient signal is in the passband. It is understood that the receiver might not achieve normal reception during the test.		
*3: Testing may be performed at other modulation frequencies identified by the RISK MANAGEMENT PROCESS.		
*4: Applies only to ME EQUIPMENT and ME SYSTEMS with magnetically sensitive components or circuitry.		
*5: During the test, the ME EQUIPMENT or ME SYSTEM may be powered at any NOMINAL input voltage, but with the same frequency as the test signal.		

*6: Before modulation is applied.

*7: This test level assumes a minimum distance between the ME EQUIPMENT or ME SYSTEM and sources of power frequency magnetic field of at least 15 cm. If the RISK ANALYSIS shows that the ME EQUIPMENT or ME SYSTEM will be used closer than 15 cm to sources of power frequency magnetic field, the IMMUNITY TEST LEVEL shall be adjusted as appropriate for the minimum expected distance.

• **Input a.c. power port**

Phenomenon	Basic EMC standard or test method	IMMUNITY TEST LEVELS
		Professional healthcare facility environment
Electrical fast transients / bursts ^{*1*12*15}	IEC 61000-4-4	±2 kV 100 kHz repetition frequency
Surges ^{*1*2*10*15} Line-to-line	IEC 61000-4-5	±0,5 kV, ±1 kV
Surges ^{*1*2*10*11*15} Line-to-ground	IEC 61000-4-5	±0,5 kV, ±1 kV, ±2 kV
Conducted disturbances induced by RF fields ^{*3*4*15}	IEC 61000-4-6	6 V ^{*13} 0,15 MHz – 80 MHz 6 V ^{*13} in ISM bands between 0,15 MHz and 80 MHz ^{*14} 80% AM at 1 kHz ^{*5}
Voltage dips ^{*6*16*18}	IEC 61000-4-11	0% UT; 0,5 cycle ^{*7} At 0°, 45°, 90°, 135°, 180°, 225°, 270° and 315° ^{*17} 0% UT; 1 cycle and 70% UT; 25/30 cycles ^{*8} Single phase: at 0°
Voltage interruptions ^{*6*9*15*18}	IEC 61000-4-11	0% UT; 250/300 cycle ^{*8}

*1: The test may be performed at any one power input voltage within the ME EQUIPMENT or ME SYSTEM RATED voltage range. If the ME EQUIPMENT or ME SYSTEM is tested at one power input voltage, it is not necessary to re-test at additional voltages.

*2: All ME EQUIPMENT and ME SYSTEM cables are attached during the test.

*3: Calibration for current injection clamps shall be performed in a 150 Ω system.

*4: If the frequency stepping skips over an ISM or amateur band, as applicable, an additional test frequency shall be used in the ISM or amateur radio band. This applies to each ISM and amateur radio band within the specified frequency range.

*5: Testing may be performed at other modulation frequencies identified by the RISK MANAGEMENT PROCESS.

*6: ME EQUIPMENT and ME SYSTEMS with a d.c. power input intended for use with a.c.-to-d.c. converters shall be tested using a converter that meets the specifications of the MANUFACTURER of the ME EQUIPMENT or ME SYSTEM. The IMMUNITY TEST LEVELS are applied to the a.c. power input of the converter.

*7: Applicable only to ME EQUIPMENT and ME SYSTEMS connected to single-phase a.c. mains.

*8: E.g. 10/12 means 10 periods at 50 Hz or 12 periods at 60 Hz.

*9: ME EQUIPMENT and ME SYSTEMS with RATED input current greater than 16 A / phase shall be interrupted once for 250/300 cycles at any angle and at all phases at the same time (if applicable). ME EQUIPMENT and ME SYSTEMS with battery backup shall resume line power operation after the test. For ME EQUIPMENT and ME SYSTEMS with RATED input current not exceeding 16 A, all phases shall be interrupted simultaneously.

*10: ME EQUIPMENT and ME SYSTEMS that do not have a surge protection device in the primary power circuit may be tested only at ± 2 kV line(s) to earth and ± 1 kV line(s) to line(s).

*11: Not applicable to CLASS II ME EQUIPMENT and ME SYSTEMS.

*12: Direct coupling shall be used.

*13: r.m.s., before modulation is applied.

*14: The ISM (industrial, scientific and medical) bands between 0,15 MHz and 80 MHz are 6,765 MHz to 6,795 MHz; 13,553 MHz to 13,567 MHz; 26,957 MHz to 27,283 MHz; and 40,66 MHz to 40,70 MHz. The amateur radio bands between 0,15 MHz and 80 MHz are 1,8 MHz to 2,0 MHz, 3,5 MHz to 4,0 MHz, 5,3 MHz to 5,4 MHz, 7 MHz to 7,3 MHz, 10,1 MHz to 10,15 MHz, 14 MHz to 14,2 MHz, 18,07 MHz to 18,17 MHz, 21,0 MHz to 21,4 MHz, 24,89 MHz to 24,99 MHz, 28,0 MHz to 29,7 MHz and 50,0 MHz to 54,0 MHz.

- *15: Applicable to ME EQUIPMENT and ME SYSTEMS with RATED input current less than or equal to 16 A / phase and ME EQUIPMENT and ME SYSTEMS with RATED input current greater than 16 A / phase.
- *16: Applicable to ME EQUIPMENT and ME SYSTEMS with RATED input current less than or equal to 16 A / phase.
- *17: At some phase angles, applying this test to ME EQUIPMENT with transformer mains power input might cause an overcurrent protection device to open. This can occur due to magnetic flux saturation of the transformer core after the voltage dip. If this occurs, the ME EQUIPMENT or ME SYSTEM shall provide BASIC SAFETY during and after the test.
- *18: For ME EQUIPMENT and ME SYSTEMS that have multiple voltage settings or auto ranging voltage capability, the test shall be performed at the minimum and maximum RATED input voltage. ME EQUIPMENT and ME SYSTEMS with a RATED input voltage range of less than 25% of the highest RATED input voltage shall be tested at one RATED input voltage within the range.

• **Signal input/output parts port**

Phenomenon	Basic EMC standard or test method	IMMUNITY TEST LEVELS
		Professional healthcare facility environment
Electrostatic discharge*4	IEC61000-4-2	± 8 kV contact ± 2 kV, ± 4 kV, ± 8 kV, ± 15 kV air
Conducted disturbance by RF field*1*3*5	IEC61000-4-6	6 V*6 0,15 MHz – 80 MHz 6 V*6 in ISM bands between 0,15 MHz and 80 MHz*7 80% AM at 1 kHz*2
<p>*1: SIP/SOPS whose maximum cable length is less than 3 m in length are excluded.</p> <p>*2: Testing may be performed at other modulation frequencies identified by the RISK MANAGEMENT PROCESS.</p> <p>*3: Calibration for current injection clamps shall be performed in a 150 Ω system.</p> <p>*4: Connectors shall be tested per 8.3.2 and Table 4 of IEC 61000-4-2:2008. For insulated connector shells, perform air discharge testing to the connector shell and the pins using the rounded tip finger of the ESD generator, with the exception that the only connector pins that are tested are those that can be contacted or touched, under conditions of INTENDED USE, by the standard test finger shown in Figure 6 of the general standard, applied in a bent or straight position.</p> <p>*5: If the frequency stepping skips over an ISM or amateur radio band, as applicable, an additional test frequency shall be used in the ISM or amateur radio band. This applies to each ISM and amateur radio band within the specified frequency range.</p> <p>*6: r.m.s., before modulation is applied.</p> <p>*7: The ISM (industrial, scientific and medical) bands between 150 kHz and 80 MHz are 6,765 MHz to 6,795 MHz; 13,553 MHz to 13,567 MHz; 26,957 MHz to 27,283 MHz; and 40,66 MHz to 40,70 MHz. The amateur radio bands between 0,15 MHz and 80 MHz are 1,8 MHz to 2,0 MHz, 3,5 MHz to 4,0 MHz, 5,3 MHz to 5,4 MHz, 7 MHz to 7,3 MHz, 10,1 MHz to 10,15 MHz, 14 MHz to 14,2 MHz, 18,07 MHz to 18,17 MHz, 21,0 MHz to 21,4 MHz, 24,89 MHz to 24,99 MHz, 28,0 MHz to 29,7 MHz and 50,0 MHz to 54,0 MHz.</p>		

(3) Test Specifications for ENCLOSURE PORT IMMUNITY to RF wireless communications equipment

Test Frequency (MHz)	Band* ¹ (MHz)	Service* ¹	Modulation* ²	Maximum power (W)	Distance (m)	IMMUNITY TEST LEVEL (V/m)
385	380–390	TETRA400	Pulse Modulation* ² 18Hz	1.8	0,3	27
450	430–470	GMRS460 FRS460	FM* ³ ±5kHz deviation 1kHz sine	2	0,3	28
710 745 780	704–787	LTE Band 13, 17	Pulse modulation* ² 217Hz	0,2	0,3	9
810 870 930	800–960	GSM800/900, TETRA800, iDEN820, CDMA850, LTE Band 5	Pulse modulation* ² 18Hz	2	0,3	28
1720 1845 1970	1700– 1990	GSM1800; CDMA1900; GSM1900; DECT; LTE Band 1, 3, 4, 25; UMTS	Pulse modulation* ² 217Hz	2	0,3	28
2450	2400-2570	Bluetooth, WLAN, 802.11 b/g/n, FRID 2450, LTE Band 7	Pulse modulation* ² 217Hz	2	0,3	28
5240 5500 5785	5100– 5800	WLAN 802.11 a/n	Pulse modulation* ² 217Hz	0,2	0,3	9

NOTE: If necessary to achieve the IMMUNITY TEST LEVEL, the distance between the transmitting antenna and the ME EQUIPMENT or ME SYSTEM may be reduced to 1m. The 1m test distance is permitted by IEC61000-4-3.

*1: For some services, only the uplink frequencies are included.

*2: The carrier shall be modulated using a 50% duty cycle square wave signal.

*3: As an alternative to FM modulation, 50% pulse modulation at 18Hz may be used because while it does not represent actual modulation, it would be worst case.

1. Overview

1-1 Instrument Overview, Components and Options

Retinomax Screen is an objective hand held refractometer, designed to measure refractive power and pupil diameter.

This equipment is intended for use indoors by medical doctors, orthoptists, and optometrists.

The refractive power measurement examines the refractive condition of the patient's eye to measure the spherical diopter power, cylindrical power, and cylinder axis angle.

The pupil diameter measurement measures the pupil size in the horizontal and vertical directions.

This instrument consists of a main unit (Retinomax Screen), Station (Retinomax Station 5), and Printer (Retinomax Printer 5).

Device and printer could be carried with ease, and contains battery, make it easier to measure and print out in small spaces. The station has function to charge, and power supply, makes it chargeable for the battery and supplies to the device and the printer.

It also has a function to transfer the measured data to PC.

■ Components

- Main unit (1)



- Station (1)



- Printer (1)



- Battery pack (1)
(RT-01XR)



- Model eye (1)



- Print paper rolls (5)
(DXA30109)

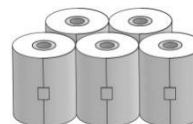

- Strap (1)
(DDB30006)



- Blower (1)

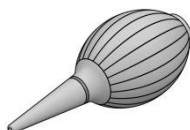

- **Fuses (2)**

(ϕ 5 x 20 mm250 V, T1.6 AH (021501.6XP))

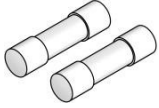

- **Power cord (1)**

- **Instruction manual (1)**

- **Dust cover (1)**

- **Options**

- **Carrying case**

- **Battery pack**

1-2 Instrument Classification

<Classification as per 93/42/EEC (MDD)>

Class IIa

<Protection type against electric shock>

Class I

This instrument is classified as equipment whose protection against electric shock does not rely on basic insulation only, but which includes an additional safety precaution, in that means are provided for the connection of the equipment to a protective earth conductor in the fixed wiring of the installation in such a way that accessible metal parts cannot become live in the event of a failure of the basic insulation. Always use the power cord shipped with the instrument. It must be connected to a receptacle outlet with a ground.

<Degree of protection against electric shock>

Type B Applied Part

The forehead rest of this instrument is a type B attachment.

Material: ABS resin

This instrument is equipped with a reliable safeguard against electric shock, as verified through testing in accordance with the applicable standard for patient leakage current.

<Protection against water and particle ingression>

IPX0

This instrument is not protected against the infiltration of water and other liquids. The instrument should not be exposed to liquids.

<Degree of safety for use in a flammable environment>

Retinomax Screen is not designed to be used in a flammable environment. Do not use it in a flammable environment.

<Disinfection method approved by the manufacture>

If necessary, clean the forehead rest with soft cloth soaked with rubbing alcohol. Cleaning conducted by a process other than the one described above may cause deterioration or damage to the equipment.

<Operation mode>

Continuous operation

1-3 Symbols on the Instrument



: This symbol on the instrument indicates the need for caution.



: This symbol indicates the necessity of referring to the relevant part of the instruction manual before use.



: This symbol indicates that the type of protection against electric shock for the applied part is type B.



: This symbol indicates that this is the place where the forehead rest is put and pulled.



: Represent a print paper outlet.



: Represent an output.

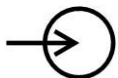

: Represent an input.



: Represent an output and input.



: This symbol indicates the main unit and the printer power switch.



: This symbol on the station indicates the on position of the power switch.





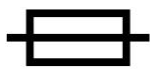





: This symbol on the station indicates the off position of the power switch.





: Represent a fuse.



: Represent a connection suitable only for DC power.

-  : The lamp indicated by this symbol on the station illuminates while the battery is charged.
-  : This symbol means that this equipment has been certified as NRTL (National Recognized Testing Laboratories) by UL (Underwriters Laboratories).
-  : This symbol means this equipment conforms to Medical Device Directive (93/42/EEC) in EU.
-  : This symbol means the manufacturer.
-  : This symbol means the manufacture date.
-  : This symbol means this equipment conforms to China RoHS (Management methods for Controlling pollution by Electronic Information Products).
-  : This symbol means this equipment conform to WEEE directive (2012/19/EU) in EU.
- 

 : This symbol is designed to promote the recycling of used lithium ion battery in Japan.
-  : This symbol is designed to promote the recycling of used batteries in Taiwan.

1-4 Labels and Marks

The product includes labels and marks to draw user's attention to important information and precautions.

If you found some scratch or rack of words, please contact to dealer whom you purchased from.

● Main unit

● Bottom

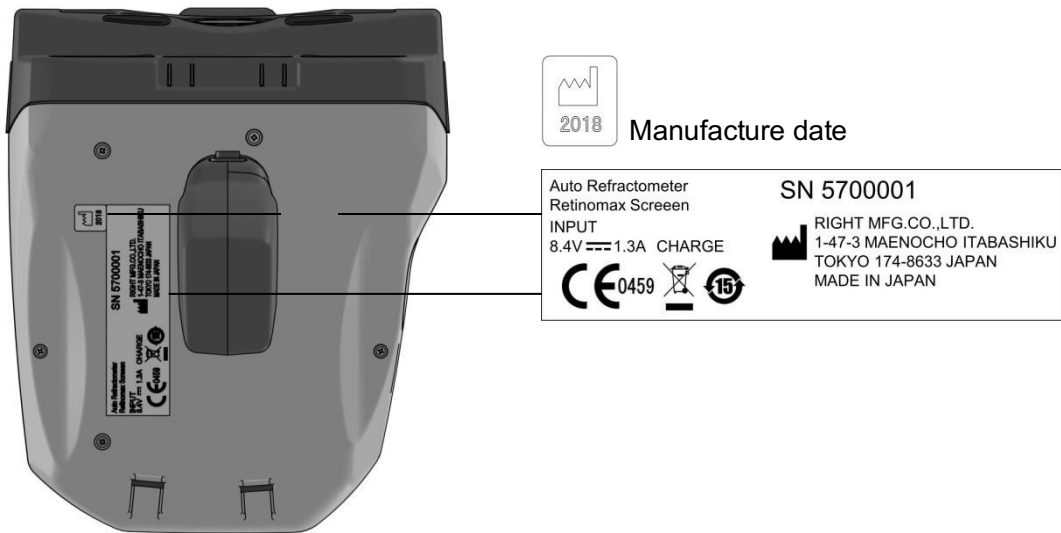

● Type B applied part

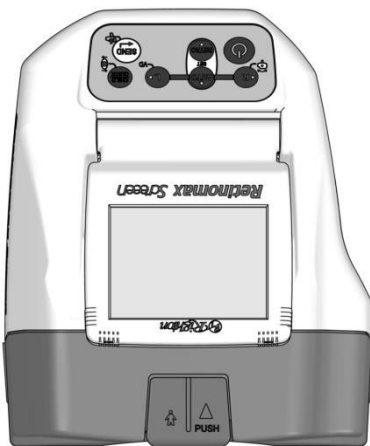

● Battery part

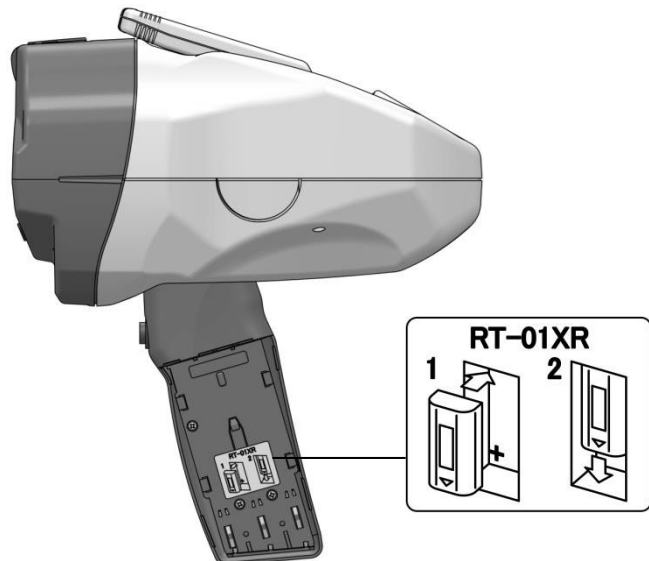

● Station

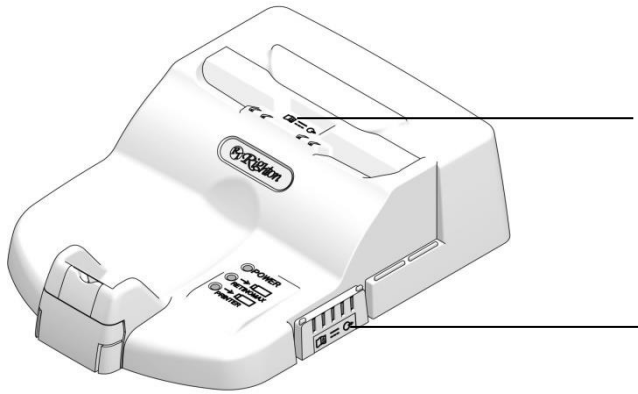

● Rear of the station

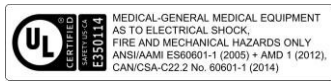

Manufacture date



Retinomax Station5 MADE IN JAPAN	SN 6100001	CE 0459	15	i
INPUT 100-240V ~ 70VA 50/60Hz	RIGHT MFG. CO., LTD.			
OUTPUT 8.8V = 2.0A PRINTER 8.4V = 1.3A CHARGE	1-47-3 MAENOCHO ITABASHIKU TOKYO 174-8633 JAPAN			
2pieces: T1.6AH 250V				
WARNING RISK OF FIRE. REPLACE FUSE AS MARKED.				
Attention Risque de feu Remplacer par fusible recommandé				

● Printer

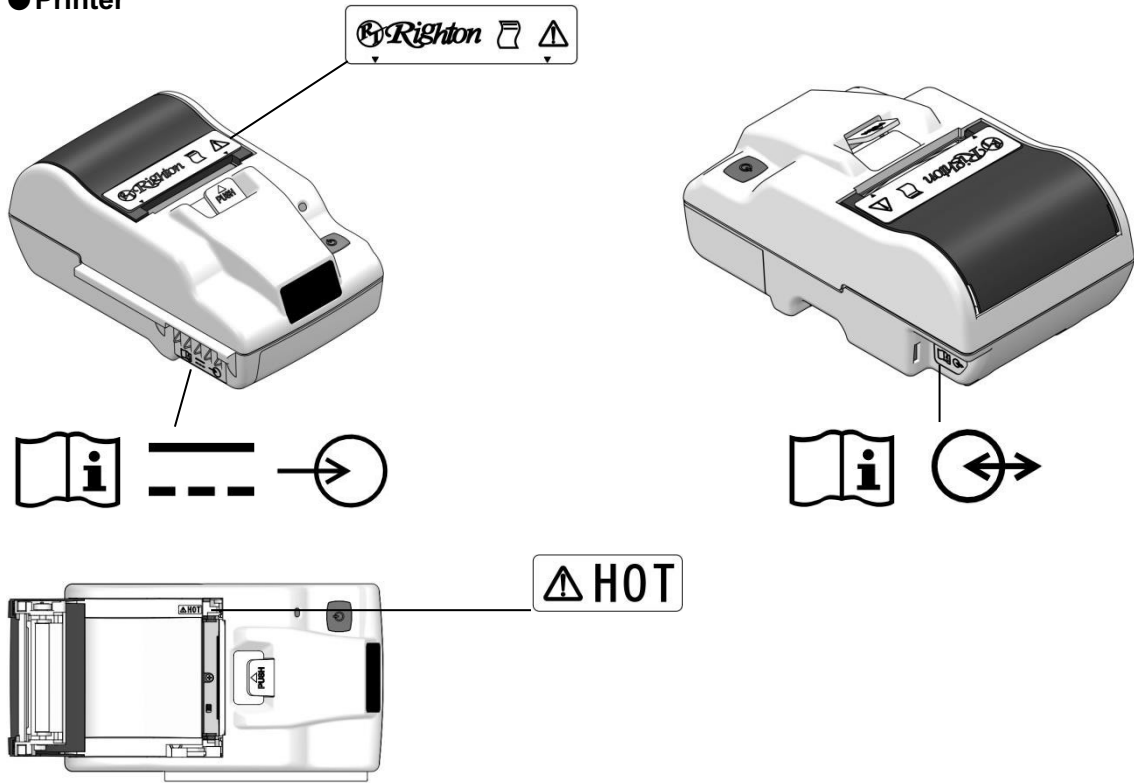

● Bottom

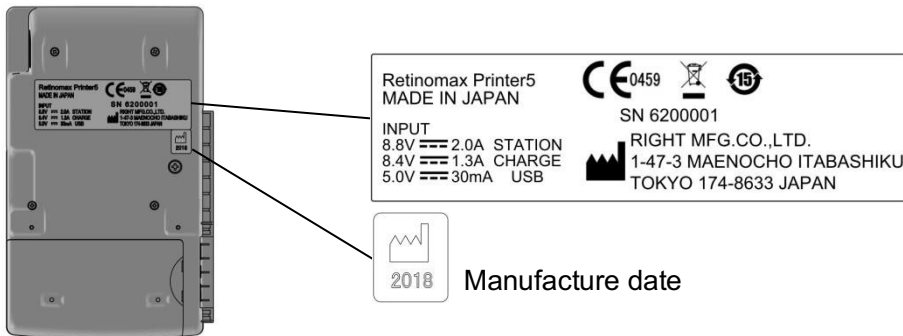

● Battery part

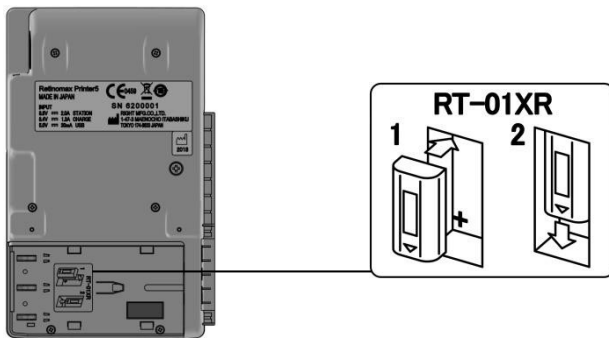

● Battery pack

 **Righton** RT-01XR
RECHARGEABLE LITHIUM ION BATTERY PACK
7.2V 2500mAh 18Wh RIGHT MFG. CO., LTD. 2IGR19/66
・取扱説明書を読んでもください。 ・READ MANUAL

MADE IN JAPAN
R-1709280100

PS
E

CAUTION
⚠ DO NOT DISASSEMBLE, SHORT CIRCUIT, DROPPING,
SOAK IN THE WATER, HEAT ABOVE 60°C,
OR INCINERATE MAY CAUSE BURST OR BURN.
USE DESIGNATED CHARGER ONLY.

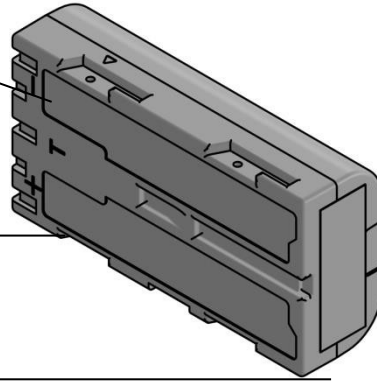

2. Name of Parts

■ System configuration



2-1 Main Unit

● Patient side

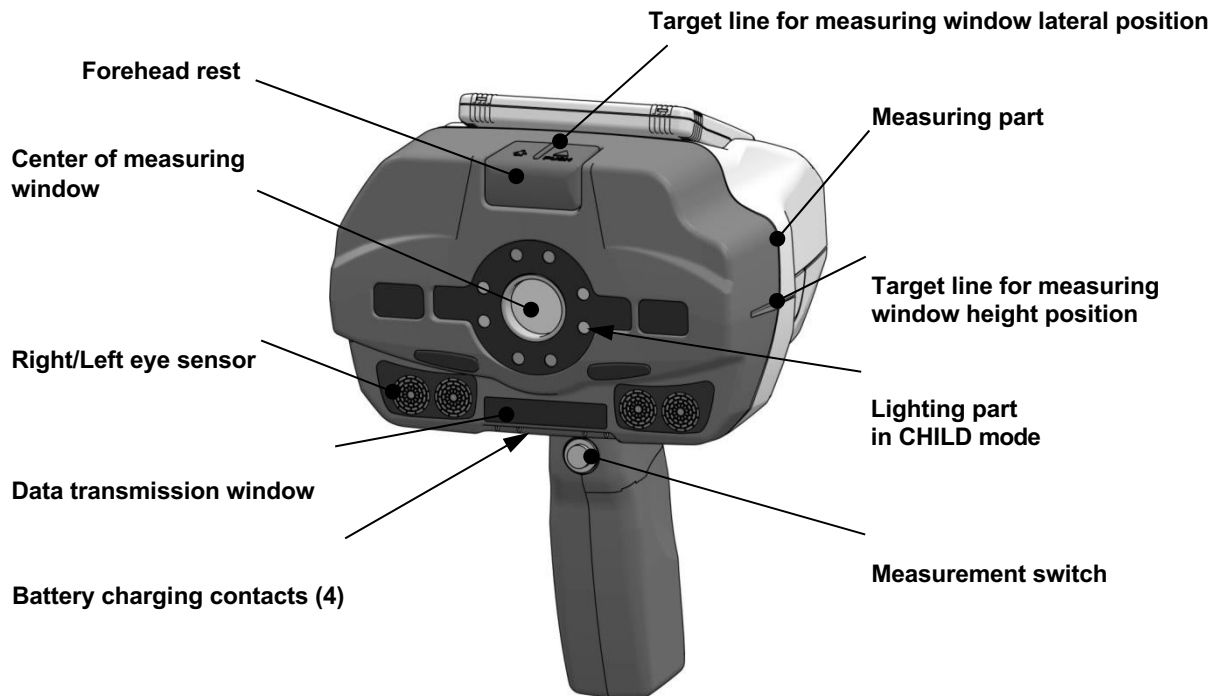

- Operator side

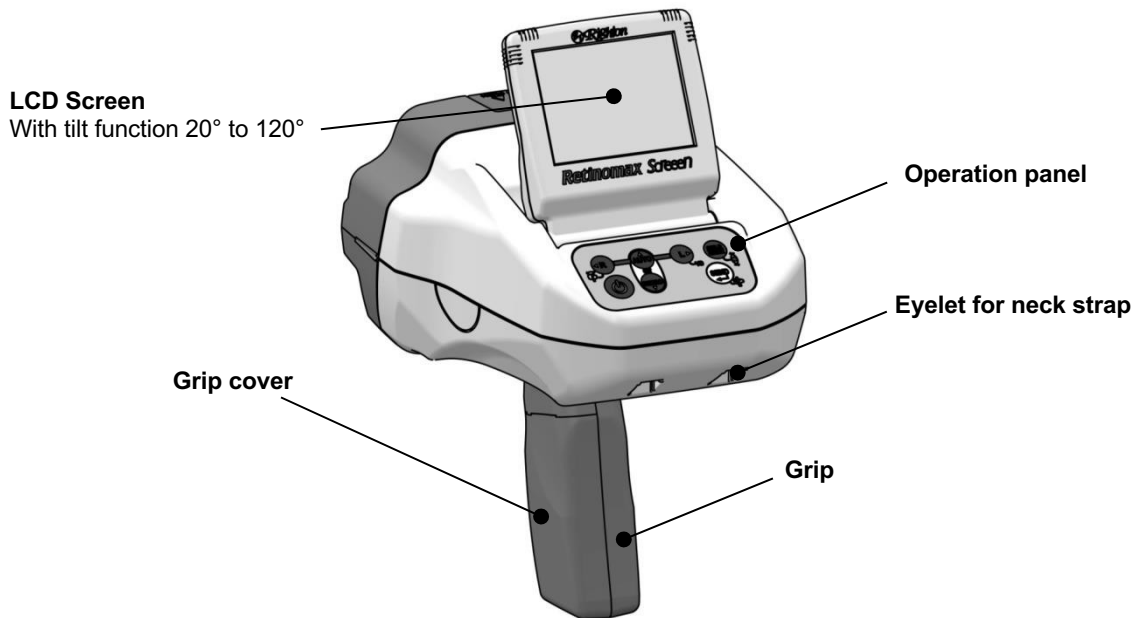





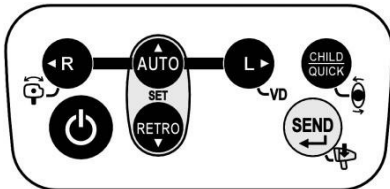

























2-2 Operation Panel

- Image of the operation panel



- Explanation and operation for main symbols

Symbol	Operation	Explanation
POWER 	Push	Turn the power on / off. Symbol will change depends on the battery pack's capacity. Green : capacity is over 50%. Orange : capacity is approximately 10 to 50%. Blinking with orange: capacity under approximately 10%. When the power is off, symbol turns off. Pressing in standby mode restore from standby mode.
	Hold down more than 2 sec in standby mode	Turn the power off.
	Push	Enters into Retroillumination mode. When it push again, goes back to the measurement standby screen.

Symbol	Operation	Explanation
<p>AUTO</p> 	Push	<p>Symbol turns on and eyes(right/left) are discriminated automatically.</p> <p>When push again or push  or , switch to manual setting of right/left eyes discrimination and symbol turns off. Please select the right/left eye to observe with  or .</p>
	Push	<p>Switch to right eye measurement and symbol turns on.</p> <p>When push during  lighting, switch to manual setting of right/left eyes discrimination.</p>
	Push	<p>Switch to left eye measurement and symbol turns on.</p> <p>When push during  lighting, switch to manual setting of right/left eyes discrimination.</p>
<p>Adjusting slope of horizon</p> 	 Hold down 2 sec	<p>Horizontal slope correction function is on. Corrects the gap produced from slope of the device. Hold down again to release.</p>
	 Hold down 2 sec	Measure with VD=0. Hold down again to release.
<p>CHILD / QUICK</p> 	Push	<p>Switch to CHILD mode and QUICK mode. Symbol is;</p> <p>blinking : CHILD mode lighting : QUICK mode</p>
<p>ANGLE</p> 	Refer to right section	<p>Rotation adjustment function is on.</p> <p>After  hold down 2 sec, push measurement switch to select the angle and push  to determine.</p> <p>Selectable angle switches to 0°/45°/90°/135°/180°/-135°/-90°/-45°/0°...</p>
	Push	Transfer the measured data to the printer.
	Hold down 2 sec after completed measuring.	<p>Perform a quick save when the memory function is off.</p> <p>Saves measured data for one eye and both eyes.</p>
<p>MEMORY</p> 	 Hold down 2 sec	<p>The symbol will light up and the memory function will be on. When measurement data is sent to the printer, it is automatically saved. Press and hold again for 2 seconds to turn off.</p>
	Push  and  at the same time	<p>Enters into the "Setup" menu enables to set up each setting.</p> <p>Move the cursor with , , ,  and decide with .</p>

2-3 Station

- Front

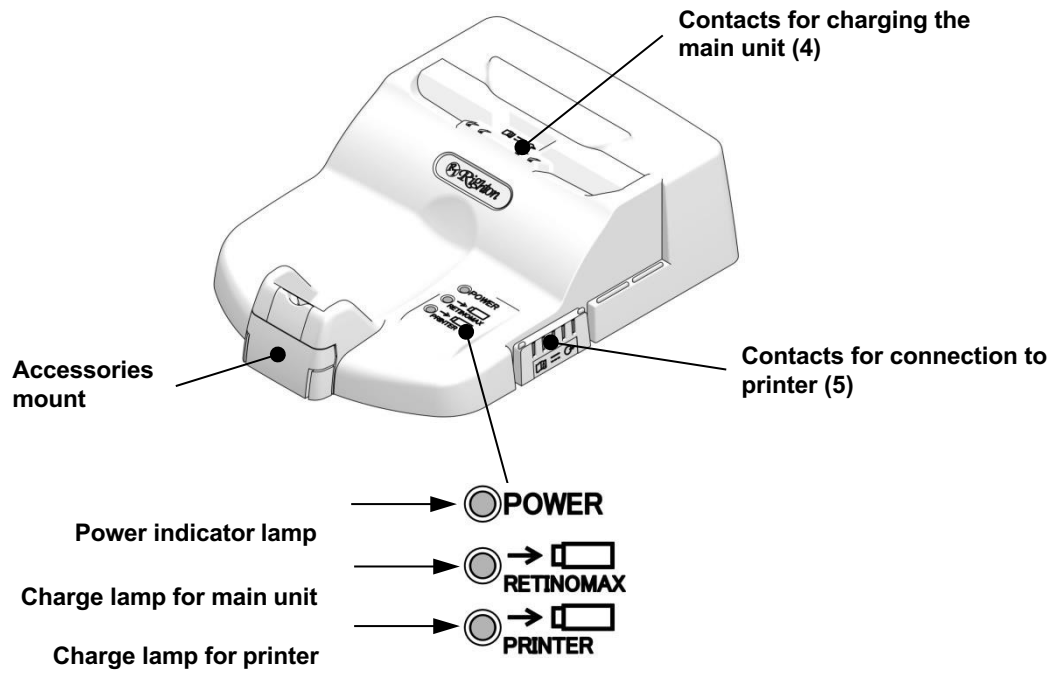

- Accessories mount

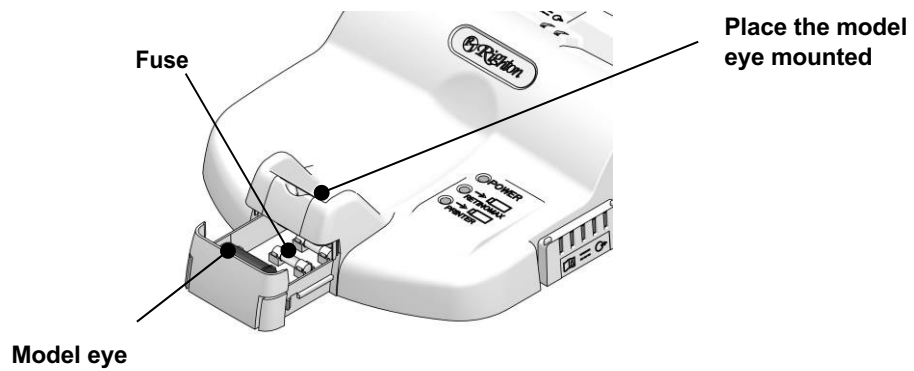

- Rear

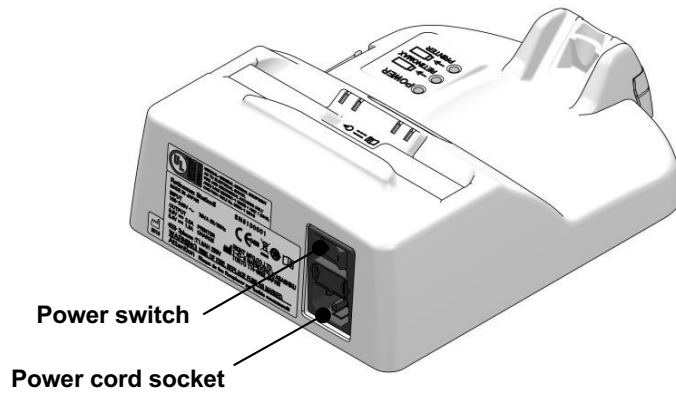

Power lamp lighting patterns

	OFF	ON	
		Charging	Completed charging
Power indicator lamp	OFF	Blue	Blue
Charge lamp for the main unit	OFF	Orange	OFF
Charge lamp for the printer	OFF	Orange	OFF

2-4 Printer

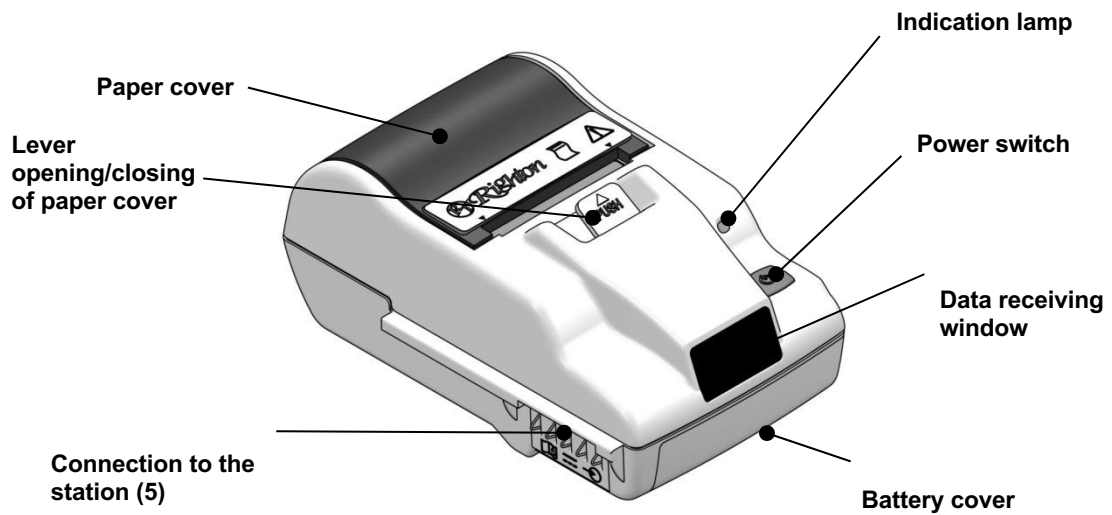

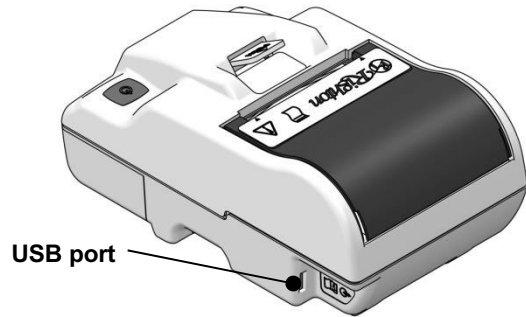
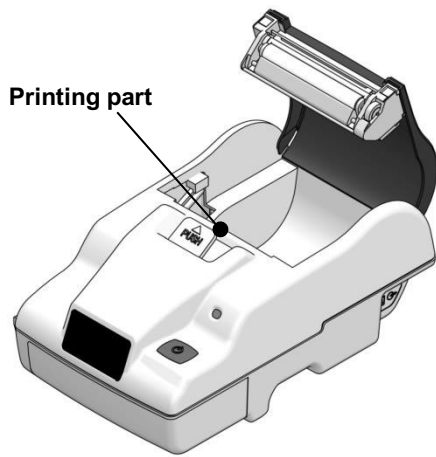

Indicator lamp lighting patterns

Situation	Indicator lamp
Power off	OFF
At battery driving: battery capacity more than 50%	Green
At battery driving: battery capacity approx. 10 to 50%	Orange
At battery driving: battery capacity less than approx. 10%	Orange (blinking)
Station supplying power	Blue
USB supplying power	Light blue
Receiving data	Pink
Error *See "8-3 Printer" (Troubleshooting)	Pink (blinking)

Data can be output to the PC while USB power is being supplied, but it cannot be printed. During battery operation, the lighting pattern will change depending on the capacity of the battery pack.



- There is a cutter on the printing part of the printer. Please be careful not to insert your finger into the print part when changing paper.

3. Setup

3-1 Attaching/Detaching the Strap

Attach the strap to the eyelets of the main unit.

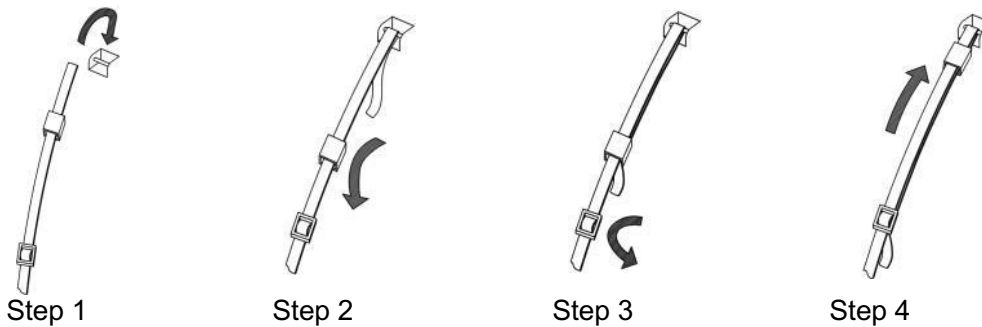

- When moving the instrument while it is in operation, hang it from your neck using the strap and hold the grip. Dropping the instrument may lead to injury or damage.
- Ensure that the strap is securely fastened.

3-2 Installing and Removing the Battery Pack

3-2-1 Main Unit

1. Open the battery cover by pressing with your fingers near the top of the cover in direction ① and sliding in direction ②.
2. To make the indication ▽ of the battery pack to the direction of ③, fit in the battery pack with the clicks, slide the battery pack to ④ to install.
3. To remove the battery pack, slide it to reverse direction of ④.
4. To close the grip cover, slide it in the opposite direction of ②. If the grip cover comes off, the screen will not be displayed even if the power is on. Please install it securely.

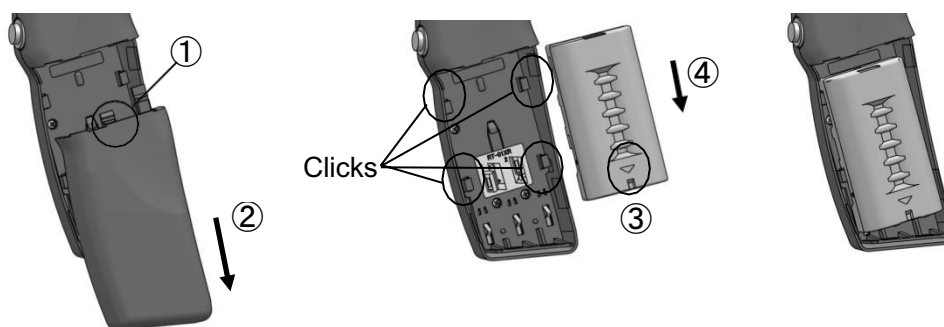

3-2-2 Printer

1. Turn the printer over.
2. Open the battery cover by pressing ① with your fingers and sliding in direction ②.
3. To make the indication ∇ of the battery pack to the direction of ③, fit in the battery pack with the clicks, slide the battery pack to ④ to install.
4. To remove the battery pack, slide it to reverse direction of ④.
5. To close the battery cover, slide it in the opposite direction of ②.

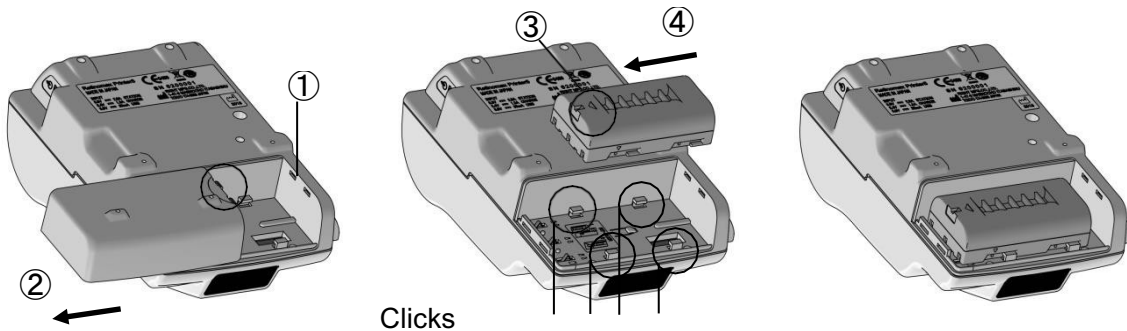

3-3 Setting Up the Instrument

1. Open the carton box, take out the main unit, the station, the printer and Accessories.
2. Place the station on flat surface.
3. In the accessory case of the station, put in model eye and spare fuse.
4. Connect the power cord to AC inlet (use power cable enclosed).
5. Make sure that the power switch on the station is set to OFF (○ side), and plug the (power plug into a power outlet.

6. On the station, set the power switch to ON (| side). The power indicator lamp will light in blue.
7. Install the battery pack onto the main unit (see “3-2-1 Main Unit”), and set in the station, battery charge will start automatically.

When using the battery pack for the first time, be sure to charge it. The battery pack is not charged at the time of purchase.

8. Set the printer at the side of the station.

Setting the printer is easily made to incline the printer.

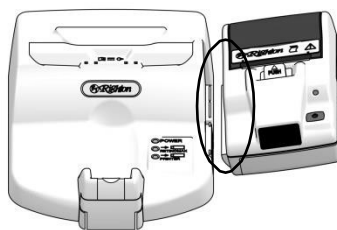

If optional spare battery is purchased, set the battery pack in the printer (see “3-2-2 Printer”) for battery charge.

9. Install the print paper roll onto the printer. (see “7-2 Replacing the Print Roll”)

3-4 Charging the Battery Pack

Be sure to read the following precautions before starting charging.

- ■Handling Precautions - Please first read for safety purposes Caution 7
- 3-4 Charging the Battery Pack ■Charging precautions
- User Manual enclosed with the battery pack
 - Charging precautions
 - When using the battery pack for the first time
 - First charge the battery pack. The battery pack is not charged at the time of purchase.
 - Charging precautions
 - When charging is complete, the battery pack and the grip of the main unit will be warm. This is normal.
 - If the battery pack remains power in a level, the station will not start charge.
 - If the charge lamp of the station blinks during charging, it may be a charge stop due to room temperature or an abnormal charge. See “8-2 Station” in “8. Troubleshooting” and check the blinking interval. If blinking interval is 3 seconds, charging stops due to the influence of room temperature. Check the room temperature and restart charging if it is between 10 °C and 35 °C. If interval is 0.5 second, it may be abnormal charging, please charge again. If blinking at 0.5 second intervals even if charging is performed again, replace the battery pack with another one. Still if it blinks at 0.5 second intervals, the station may be abnormal, please contact your dealer.
 - The main unit or the printer can be removed from the station and used before the charging is completed.
 - Precautions on contacts
 - The charging may fail if the contacts are dirty.
 - Be careful not to touch the station contacts (recessed parts), the main unit contacts (pins on the front of the main unit), and the printer contacts (side pins). Also, do not touch the contacts (plates) of each battery pack.
 - If the contacts are touched or dirty, turn off equipment, and wipe them clean with a dry cloth.



CAUTION

- Only use the RT-01XR battery pack, which is our designated lithium ion battery. Use of any other battery voids the operation warranty.
- The battery provided with Retinomax, Retinomax 2, Retinomax 3 cannot be used.
- Never disassemble or modify the battery pack.
 - Never short-circuit the terminal of the battery pack. Otherwise, heating may occur, leading to burn injury or a fire. Also, keep metal objects (coins, paper clips, etc.) away from contact with the terminal area.

3-4-1 Automatic Charging of the Main Unit

To automatically charge the battery pack of the main unit, follow these steps.

1. See “3-3 Setting Up the Instrument”, on the station, set the power switch to ON (“I” side).

2. When the main unit is placed onto the station, the charge lamp lights with orange color.

The station automatically checks the state of charge and decides whether the battery needs charging.

If charging is not needed → the lamp goes out.

If it is needed → the lamp continues lighting with orange color.

The main unit is turned off while connecting with the station.

3. When the charging is completed, the charge lamp for the main unit goes out.



- Fit the main unit completely on the station. Otherwise, the contacts may not be connected and fail to charge the battery pack.
- Check that a battery pack is in the main unit.
 - When the main unit is connected to the station and the power is on, the station regularly checks the state of charge. If the capacity becomes low due to natural discharge, the battery pack will be automatically recharged, keeping it above a certain level.
- Charging time varies depending on the age of the batteries, etc.

3-4-2 Automatic Charging of the Printer

To charge the battery pack in the printer automatically, follow these steps.

1. See “3-3 Setting Up the Instrument”, on the station, set the power switch to ON (“I” side).
2. Connect the printer to the station, charging lamp lights with orange color.

The station automatically checks the state of charge and decides whether the battery needs charging.

If charging is not needed→the lamp goes out.

If it is needed→the lamp continues lighting with orange color.

3. When the charging is completed, the charge lamp for the printer goes out.



- Place the station and the printer on a flat surface. If placed on an unstable place, the station and the printer may not connect properly.
- When the printer is connected to the station and the power is on, the station regularly check the state of charge. If the capacity becomes low due to natural discharge, the battery pack will be automatically recharged, keeping it above a certain level.
- Charging time varies depending on the age of the batteries, etc.



CAUTION

- When connecting the printer to the station, make sure to use the one provided with Retinomax Screen or Retinomax K+Screen.
- Do not use the printer provided with Retinomax, Retinomax 2, Retinomax 3.

3-4-3 Charging a Spare Battery Pack

Insert the battery pack you want to charge into the printer and charge it. See “3-2-2 Printer” for how to install the battery pack and “3-4-2 Automatic Charging of the Printer” for charging method.

4. Measurement

• Measurement Procedure

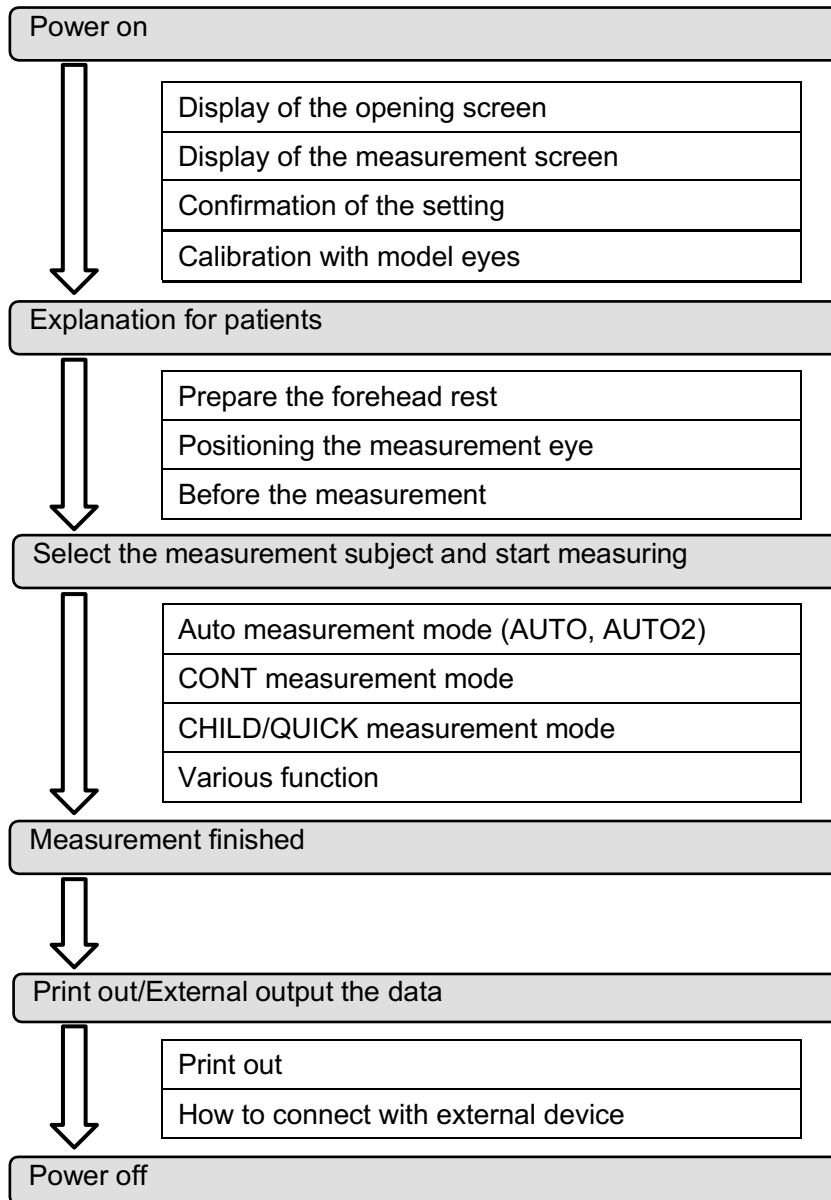

4-1 Power on

Press  on the operation panel. The symbol turns on green and the opening screen appears.

4-1-1 Opening Screen

After displayed opening screen, measurement standby screen is displayed.

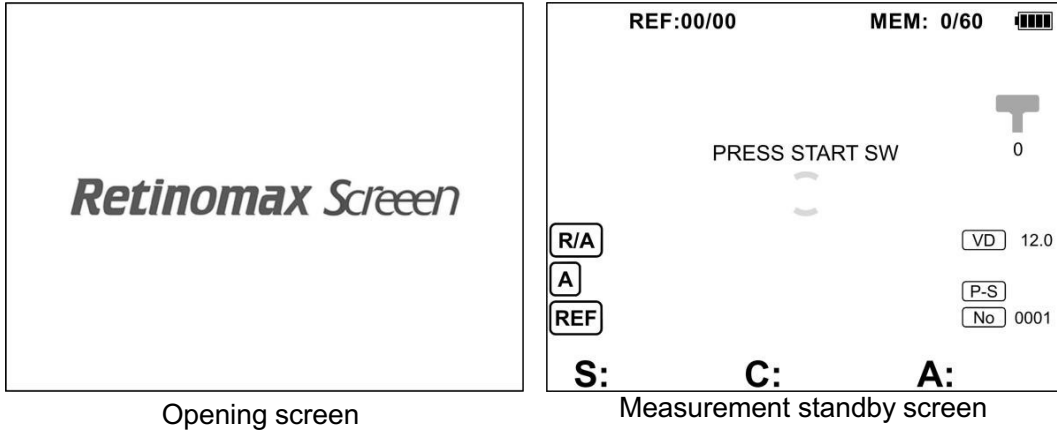

4-1-2 Measurement Screen

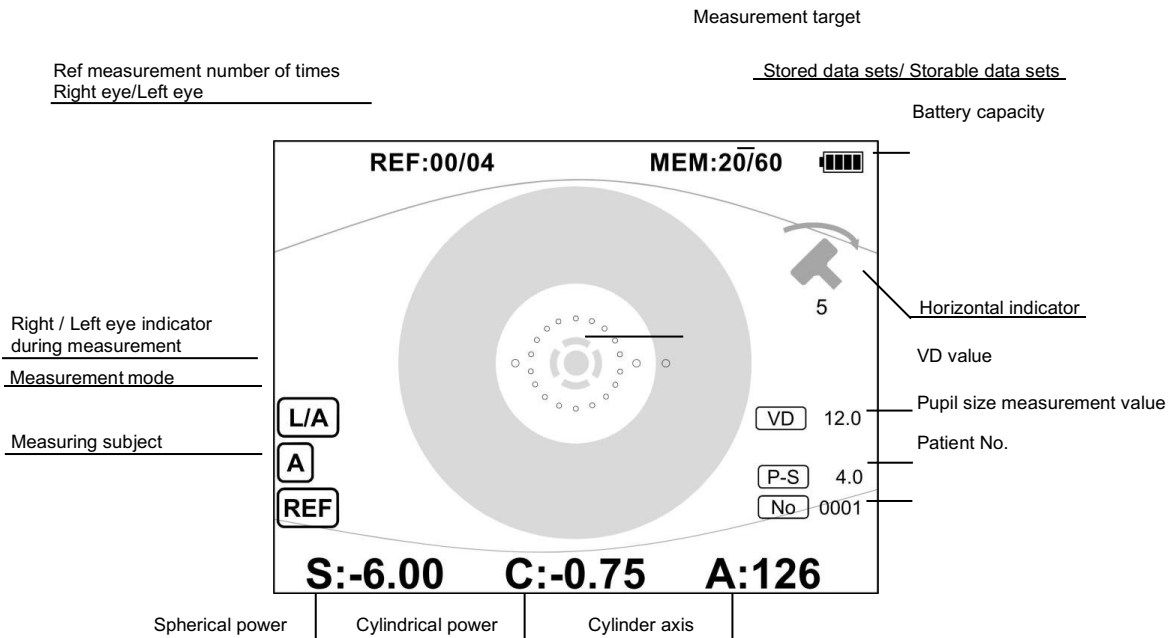





Reference and examples of measurement screen







Battery capacity

	More than 50%
	Less than 50%
	Less than 10%

Right / Left eye indicator during measurement

	Right eye measurement by R/L eyes automatic discrimination
	Left eye measurement by R/L eyes automatic discrimination
	Right eye measurement by R/L eyes manual setting
	Left eye measurement by R/L eyes manual setting

Measurement mode

	AUTO mode
	AUTO2 mode
	Continuous measurement (CONT) mode
	CHILD mode
	QUICK mode
	QUICK mode by AUTO QUICK function

Measurement subject

	REF measurement
---	-----------------

Target

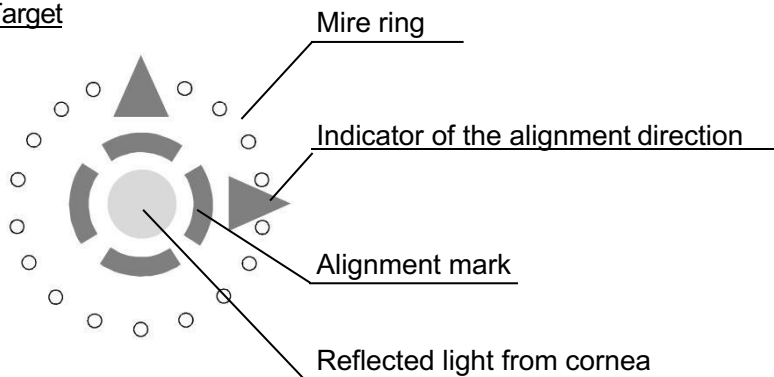

4-1-3 Setting Confirmation

Confirm the setting with [SETUP]

[SETUP]	18. 06. 15 3:30 PM
[EXIT]	
[MEASURE]	[POWER OPTION]
[OUTPUT]	[PATIENT No]
[MEMORY]	[MESSAGE]
[CHILD]	[INITIAL]
[OTHER]	[VERSION]
[CLOCK]	
UP : AUTO SW DOWN : RETRO SW RIGHT : L SW LEFT : R SW SELECT : SEND SW	

Subjects	Setting contents
EXIT	Finish the [SETUP]
MEASURE	Change measurement setting
OUTPUT	Change output setting
MEMORY	Output and delete stored data
CHILD	Change CHILD mode setting
OTHER	Change other setting
CLOCK	Change time setting
POWER OPTION	Change power supply setting
PATIENT No	Set patient No.
MESSAGE	Input a message
INITIAL	Implement initialization
VERSION	Confirm the version

Initialization settings are as follow. See “5. Setting Up the Instrument”.

■MEASURE

TYPE	AUTO
P-S	ONE
CYL	—
VD	12.0
STEP	AUTO

■OUTPUT

■OUTPUT SETTING

OUTPUT	PRINT & USB
PRINT ID	1
USB FORMAT	PC

■OUTPUT FORMAT

REF	ALL
P-S	ON
MESSAGE	OFF
EYE	OFF

■CONT FORMAT

OUTPUT DATA	LAST5
REF	ALL
P-S	ON
MESSAGE	OFF

■MEMORY

OUTPUT NUMBER	LAST30
PRINT	—
USB	—
PRINT & USB	—
DELETE	—

■CHILD

MELODY	ON
LED	ON
CHART COLOR	ON

■OTHER

BUZZER	ON
ALIGN	OFF
CHART BRIGHTNESS	AUTO
LCD	80%
PARALLEL	ON
FOCUS ASSIST	ON
AUTO QUICK	OFF

■CLOCK

DATE-FORM	120V area MDY 230V area DMY
TIME-FORM	120V area AM/PM 230V area 24H

■POWER OPTION

STAND-BY	3MIN
SHUT-DOWN	3MIN

■PATIENT No.

No.	0001
-----	------

4-1-4 Measuring the Model Eye

1. Open the accessory case, and, place model eye.

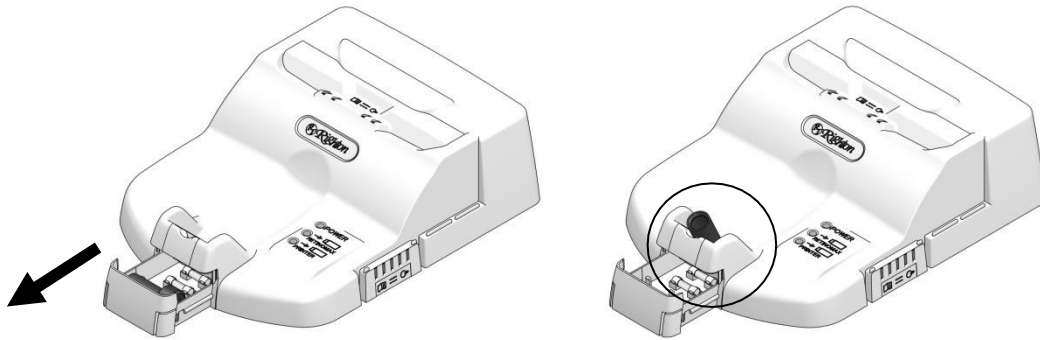

2. Make sure setting with AUTO mode and VD12.0mm.
3. Focus on model eye and start measurement.

*See “4-3-1 Automatic Measurement Mode (AUTO, AUTO2)” to be acknowledged how to measure.



- Do not expose the main unit to bright light.

Exposure to light may lead to loss of measurement accuracy or failure of the measurement.

4. Compare the values measured with the model eye against the values (SPH, CYL) printed on the model eye. Confirm that the differences are within the following ranges:

SPH : ± 0.25 D CYL : ± 0.25 D

Make sure that the model eye and measurement window are not dirty.

If the surface of the measurement window becomes dirty with patients' nose grease or fingerprints or dust, the measurement results may be affected.

If the measured values are out of the above ranges, see "4-3-1 Automatic Measurement Mode (AUTO, AUTO2)" and check that your measurement procedure was correct. Then, retry the measurement.

Also check for dirt as described in "7-5 Cleaning the Measurement Window" and "7-6 Cleaning Model Eye". If dirty, perform cleaning. If the values still do not fall within the above ranges, contact your local dealer.

4-2 Preparation for Patient

4-2-1 Prepare the Forehead Rest

When pushing the place at the following figure until it makes a sound, the forehead rest automatically comes out. When closing it, push there until it makes a sound.

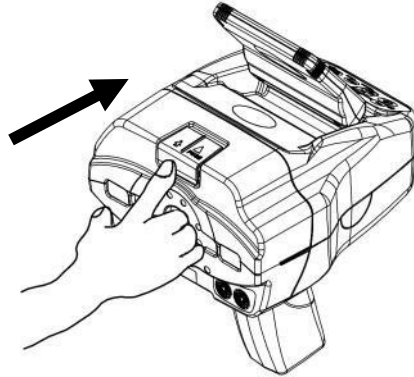

CAUTION

- If the patient moves frequently, especially a child, the case that injure their face, do not use forehead rest.

4-2-2 Positioning the Measurement Eye

Make sure the position of the patient eye approximately.

- Vertical : Align to the target line for measuring window height.
- Lateral : Align to the target line for measuring window lateral position.
- Back and forth : Position the measuring window approximately 50mm away from the eye.

Hold the patient's head gently to facilitate anteroposterior positioning.

The positioning can be made still easier by bringing the forehead rest into contact with the patient's eyebrow.

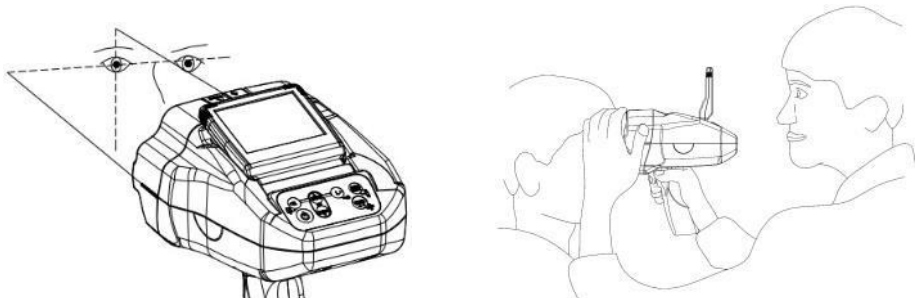

4-2-3 Before the Measurement

Clean the forehead rest each patient with soft cloth soaked with rubbing alcohol.

Patients tend to be a little nervous, because they do not know what will happen to them, so it is best to try to relax and give them enough explanation.

Briefly explain the following:

- “This instrument automatically measures your eyes to determine the spectacle lenses that best suit you”.
- “Please look at the center in a relaxed manner”.
- “Try to keep your eye as still as possible”.

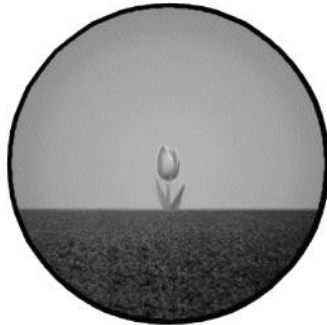

Example of a “tulip” fixation target



- When taking a measurement with 90° rotation or from the patient's vertex, the patient sees the fixation target rotated by 90° or 180° , respectively. In a measurement with 45° or 135° rotation, the patient sees the fixation target tilted diagonally.



CAUTION

- You may fail to find the eye through the LCD screen, and this can lead to the danger of having the main unit come in contact with the patient.
- It is important to approximately align the main unit and the patient's line of sight before looking into the LCD screen.

4-3 Measurement Modes and Start Measuring

This instrument offers three measurement modes.

Measurement mode is selected from SETUP menu. See "5-1 Measurement Setup [MEASURE]".

The operation of each measurement mode is shown on the following table.

Measurement subject Measurement mode	REF
<p>A:Auto measurement mode See "4-3-1 Automatic Measurement Mode (AUTO, AUTO2)". Press the start switch once, place the bright spot within the alignment mark, and focus the mire ring. When the instrument judges that the measurement values are stable, the measurement will end automatically.</p>	<pre> Start ↓ Fog ↓ REF measurement (Measure 5 times at least) ↓ Auto stop </pre>
<p>A2:Auto measurement mode2 See "4-3-1 Automatic Measurement Mode (AUTO, AUTO2)". As same as Auto measurement mode, but, do Fog on each REF measurement.</p>	<pre> Start ↓ Fog ↓ REF measurement ↓ Fog ↓ REF measurement . . (Measure 5 times at least) ↓ Auto stop </pre>
<p>C:Continuous measurement mode See "4-3-2 Continuous Measurement Mode (CONT)". As with the automatic measurement mode, can be interrupted by a press of the start switch.</p>	<pre> Start ↓ Fog ↓ REF measurement (Continuous measurement) ↓ Stop with pushing measurement switch </pre>

4-3-1 Automatic Measurement Mode (AUTO, AUTO2)

This enable you to REF measurement. The operation method of AUTO mode and AUTO2 mode is the same.

1. Enter to [SETUP] with , select measurement mode “AUTO” or “AUTO2” with <TYPE> in [MEASURE].
See “5-1 Measurement Setup [MEASURE]”.
2. Make patient relaxed by talking to them, and, position the patients’ eye approximately.
See “4-2-2 Positioning the Measurement Eye”.

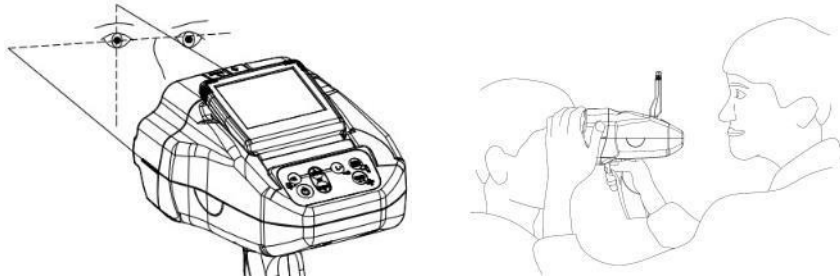

- Be careful not to allow the main unit to touch the patient's eyelashes.

3. When the  is lighting, as you move the main unit closer to the patient, the automatic right/left eye discrimination function begins.

A beep sounds to indicate that the measurement has changed from the patient's right eye to left eye, or vice versa.

However, the right/left eye discrimination is unstable, and a continuous beep may sound. If you find it difficult to properly discriminate the right/left eyes, see “4-7-1 For Proper Measurement”.



- The beeping in the automatic right/left eye discrimination mode is turned off by setting the <BUZZER> to “OFF” at [OTHER] in [SETUP].

 **CAUTION**

- When measurement, the case you make movement with the device right and left, not to hit forehead rest to patient's nose.
- It is safe that move it after separated from patient.

4. With the patient's eye positioned approximately, look into the screen during the measurement.

When the patient's eye appears on the screen, align the image of the pupil to the center of the screen.

Next, move the main unit back or forth until the image of the dots of the mire ring appears clearly.

5. Focus on the mire ring and put the alignment mark in it.

 **CAUTION**

- You may fail to find the eye through the LCD screen, and this can lead to the danger that the main unit may come in contact with the patient. It is important to approximately

6. When push the measurement switch, the measuring light turns on and the cornea reflected light is visible in the center of the mire ring. When the cornea reflected light enters the alignment mark and the alignment is correct, the alignment mark changes color from white to green and automatically started measuring.

Select [OTHER] in [SETUP] and set <ALIGN> to "ON", the alignment direction indicator will be displayed. Moving the main body in the display direction makes it easier to acquire measurement values. Move the main body in the direction to be displayed to make it easier to obtain measured values.

Select [OTHER] in [SETUP] and set <PARALLEL> to "ON", the horizontal indicator displays the tilt of the unit in 2° increments. When the horizontal level of the device is within ± 2°, the indicator icon turns green. Please keep green as possible and measure.

If it is difficult to find the focus position of the mire ring, "4-4-3 Focus Assist Function" is enable to display the positional displacement in the anteroposterior direction.

Alignment direction indicator

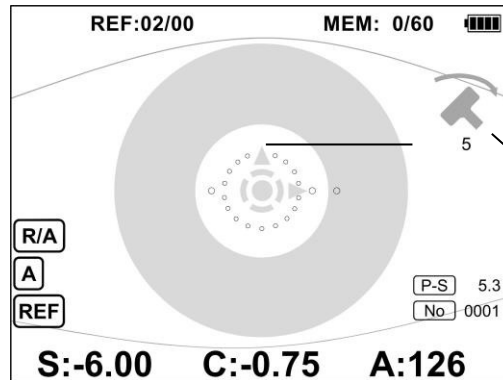

Horizontal indicator

REF measurement screen

7. The device judges the variation of the measurement data and it will automatically end when the measurement value becomes stable. If you want to finish the measurement in the middle of the measurement, press the measurement switch or switch the right/left eyes during measurement. When measurement of one eye is completed, it becomes as shown below.

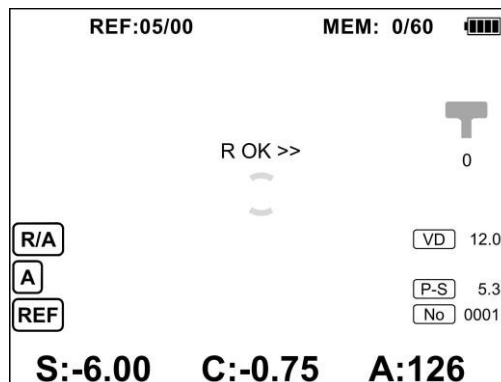

Completed one eye measurement

If you want to finish the measurement and send the data to printer, please press . See “4-5 Printing” for the data transmission method, “4-5-2 Printing Examples” for the print example, and “5-2 OUTPUT Screen [OUTPUT]” for the printing settings.

If you want to measure the same eye again, press the measurement switch and implement measurement with the process from 3 to 7.



8. When you completed measuring the one eye, implement the other eye with 3 to 7 process.
9. If you completed measuring of both eyes, measurement data will be displayed.

REF:05/05		MEM: 0/60		■■■■	
[REF]	SPH	CYL	AX	P-S	CV
R	- 6.00	- 0.75	126	4.0	10
L	- 6.00	- 0.25	52	4.7	10

	No	0001
	VD	12.0
R	AX	--
L	AX	--

A	SAVE & SEND : SEND SW	EXIT : START SW
----------	-----------------------	-----------------

Completed both eyes measurement

10. To print out the measurement results, aim the front side of the main unit toward the printer's data receiving window, push  button. When the memory function is on, the data is automatically memorized when the data is transferred. When the memory function is off, hold down  for 2 seconds to save the data. For details on memory function, see "4-4-7 Storing Data".
11. After completed transferring data, the case measure the other patient, push measurement switch and implement 3 to 9 process.

A black shadow develops if the pupil has a something that obstructs light during measurement (such as opacity in the crystal lens due to a cataract, scars in the eye, etc.)

If a black shadow is seen, we recommend performing the observation followed by Retroillumination Mode and other ophthalmic examination such as using a slit lamp. See "4-4-6 Retroillumination Mode".



- To start the measurement again with the same patient's eye to be examined, press the start switch again. From the measurement completion screen, return to the measurement standby state.
- Measured values are stored for up to 8 times of the latest data on each side. If you measure more than 8 times, the oldest data will be erased in order.

4-3-2 Continuous Measurement Mode (CONT)

In this mode, measurement is performed continuously without finishing automatically.

1. Enter [SETUP] with  and set the measurement mode to “CONT” with <TYPE> in [MEASURE].
2. Take a measurement using the same procedure of 3 to 9 as in the “4-3-1 Automatic Measurement Mode (AUTO, AUTO2)”.

During measurement, a graph of spherical equivalent power, spherical equivalent average (AVE), spherical equivalent maximum (FAR) are displayed on the left side of the screen.

AVE: average

FAR: maximum value

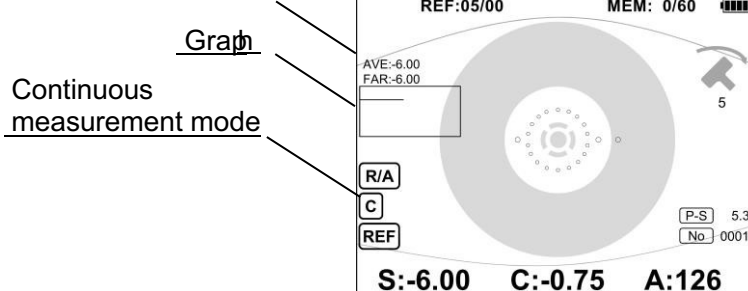

Sample screen at measurement (CONT)





- In this mode, measurement does not end automatically.
 - We recommend that the measurement be performed at least 5 times for one eye. Increase the number of measurement cycles further if the eye moves frequently or measurement values vary.

3. If you wanted to end the one eye measurement, press the measurement switch.
Or, change to the other eye while measuring.
4. When completed measuring both eyes, moves on to screen completed measurement.
5. To print out the measurement results, aim the front side of the main unit toward the printer's data receiving window, push . When the memory function is on, the data is automatically memorized when the data is transferred. See “4-5 Printing” for the data transmission method, “4-5-2 Printing Examples” for the print example, and “5-2 OUTPUT Screen [OUTPUT]” for the printing settings.

When the memory function is off, hold down  for 2 seconds to save the data. For details on memory function, see “4-4-7 Storing Data”.

4-3-3 CHILD/QUICK Mode

Press , the symbol will be blinking and goes on to CHILD mode. In CHILD mode, apply QUICK mode automatically in order to shorten the measurement time. Press  again to goes on to QUICK mode, the symbol will be lighting and CHILD mode will be off.

<CHILD mode>

The case that measure children, sometime they dislike to be measured. This instrument contains function that make them pay attention by making sounds, lighting fixation chart in various color and LED blinking with various color. It functions, as aid, until them to be measured.



Blinking point (8)

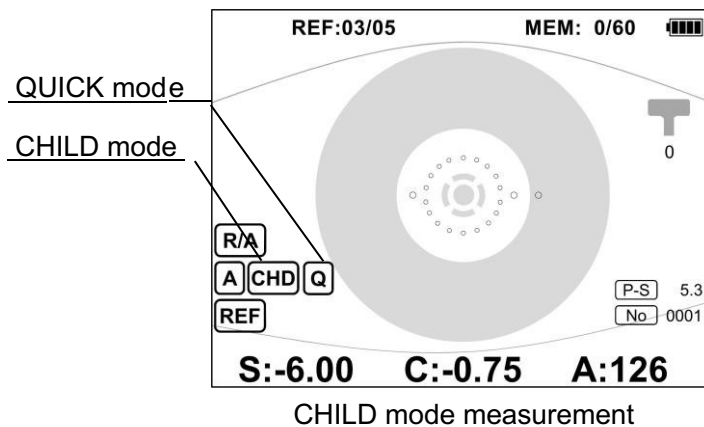

LED blinking, lighting the fixation chart and melody ON/OFF in CHILD mode can be set with CHILD mode setting screen [CHILD] in [SETUP]. See “5-4 CHILD Mode Screen [CHILD]”.

Perform the measurement in the same process as “4-3-1 Automatic Measurement Mode (AUTO, AUTO2)” and “4-3-2 Continuous Measurement Mode (CONT)”.

When measuring in CHILD mode, “CHD” is displayed on the printed data.

-REF-				
[R]	SPH	CYL	AX	
-	6.00	- 0.87	150	CHD
-	6.25	- 1.12	152	CHD
-	6.50	- 0.75	168	CHD
-	6.50	- 0.37	165	CHD

Printing example



- Use this function when you found it difficult to measure children.
- When you sound the melody, buzzer will never ring.

<QUICK mode>

The “Quick Measurement Mode” allows a shortening of the time from the start of measurement to display the measurement value.

QUICK mode with short REF measurement time is useful in cases when measurement is difficult because of rapid eye movements due to nystagmus or if the patient is a child, or other reason.

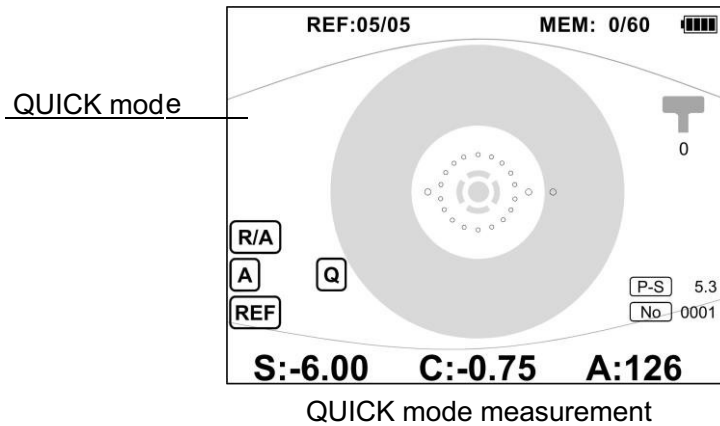

Perform the measurement in the same process as “4-3-1 Automatic Measurement Mode (AUTO, AUTO2)” and “4-3-2 Continuous Measurement Mode (CONT)”.

When measuring in QUICK mode, “Q” is displayed on the printed data.

-REF-				
[R]	SPH	CYL	AX	
-	6.00	- 0.87	150	Q
-	6.25	- 1.12	152	Q
-	6.50	- 0.75	168	Q
-	6.50	- 0.37	165	Q

Printing example

- 
 In the quick measurement mode, refractive measurement takes about half the ordinary time, but measurement values tend to vary more widely.

4-4 Various Functions

4-4-1 Pupil Diameter Measurement Function

This instrument is equipped with a pupil diameter measurement with REF measurement.

- Enter to [SETUP] with , set <P-S> in [MEASURE] to "ONE" or "ALL".
 - When the <P-S> is "ONE", pupil diameter is measured only once (first time) for each eye.
 - When the <P-S> is set to "ALL", the pupil diameter measurement is always performed after the REF measurement.
- When the measurement started, pupil diameter measurement automatically started after each REF measurement. If measurement data obtained, measurement value will indicated in <P-S> on the right side of the screen.

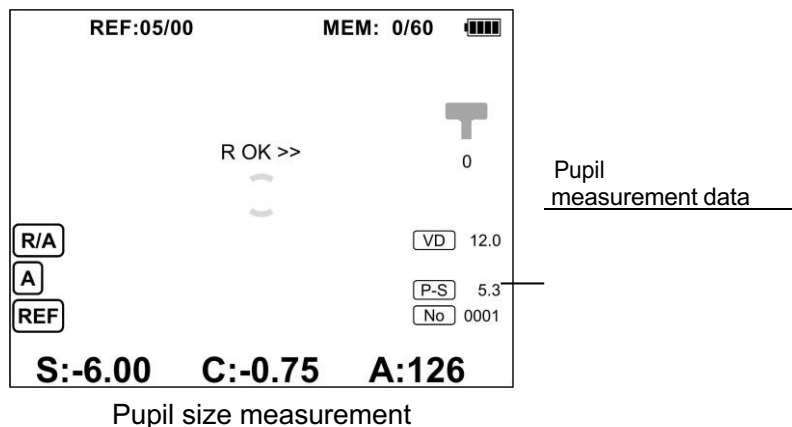

- The maximum values of pupil diameter both lateral and vertical directions are measured. If the pupil diameter less than 2.0mm, pupil diameter are displayed as " _ _".

Figure indicates only lateral direction.

Range of measurement : 2.0 mm to 12.0 mm

Measurement step : 0.1mm

- When the pupil diameter is 3.0mm or less, "SMALL PUPIL" will be indicated on the measurement screen. At this time, when <CHART BRIGHTNESS> with [OTHER] in [SETUP] is set to "AUTO", the brightness of the fixation chart is automatically dimmed. See "5-5 OTHER Setting [OTHER]".

By the fixation chart brightness, the character color of P-S will be changed as follows.

	P-S : green	The fixation chart brightness is "HIGH".
	P-S : red	The fixation chart brightness is "LOW".

4. If the pupil diameter less than 2.3mm, REF measurement value is displayed as “—”.
5. When < P-S > is set to “ONE”, if the pupil size measurement value is less than 2.3 mm, pupil size measurement is performed again, and if it is 2.3 mm or more, normal measurement is performed. Measure the pupil size 3 times and if all diameters are less than 2.3 mm, measurement of one eye is ended and an error display is made as follows.

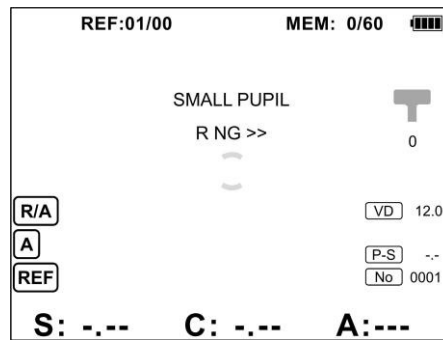

Error indication when data cannot be obtained because the pupil size is less than 2.3 mm

6. When < P-S > is set to “ALL”, measurement is performed 5 times. The variation is judged from REF measurement value when the pupil size is 2.3 mm or more, and if stable data is obtained, the measurement will be completed. Measure the pupil size 5 times and if all diameters are less than 2.3mm, measurement of one eye is finished and the error display just as when <P-S> is set to “ONE” is made.

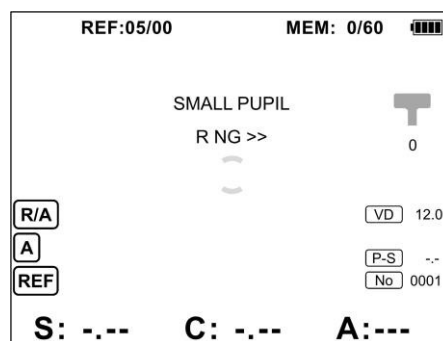

Error indication when data cannot be obtained because the pupil size is less than 2.3 mm

7. If REF measurement value cannot be obtained because the pupil size is less than 2.3mm, an error is displayed on measurement completed screen as follows.

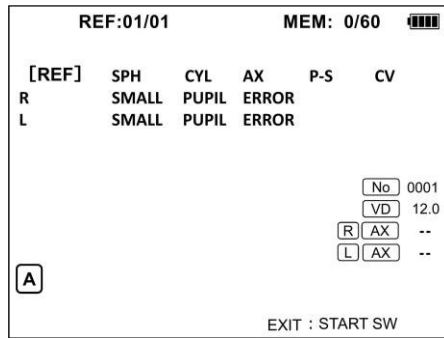

Measurement completed screen when data cannot be obtained because the pupil size is less than 2.3 mm

4-4-2 Alignment Direction Indication Function

The alignment direction indication function is used to indicate the direction for placing the refracted light from cornea within the alignment mark during the measurement.

Move the main unit in the indicated directions, and measurements will be obtained more easily.

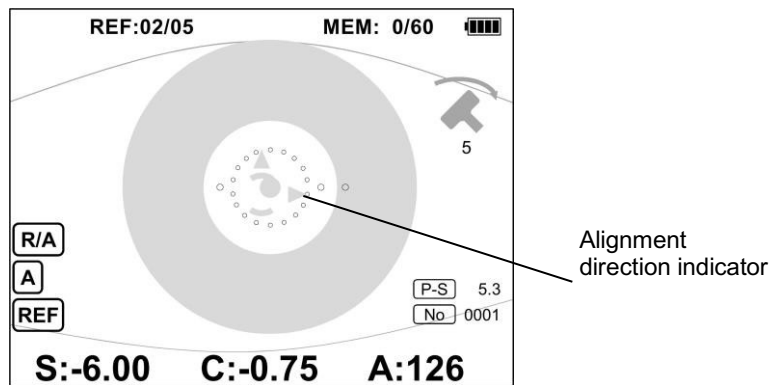

Measurement screen when alignment is on



1. Enter to [SETUP] with , set <ALIGN> in [OTHER] to "ON".
2. Start the measurement and indicator is displayed.
3. Moving the main unit in the indicated directions marks establishes proper alignment. When the direction marks are shown as seen in the figure above, proper alignment can be established by moving the main unit toward the upper right.

4-4-3 Focus Assist Function

This function notices that the range between instrument and eye is too close or too distant from the focus position. It is convenience function if it is not used to focus on the mire ring or want to measure at the exact position.

1. Enter to [SETUP] with  and setting with <FOCUS ASSIST> in [OTHER].

ON	Automatically measure when matched focus and alignment.
DISPLAY	Indicates focus. No auto measurement.
OFF	The function is off.

2. The indicator for focus assist will be displayed when it set “ON” or “DISPLAY”.
According to the indication, move instrument to front-back direction, and focus the mire ring.

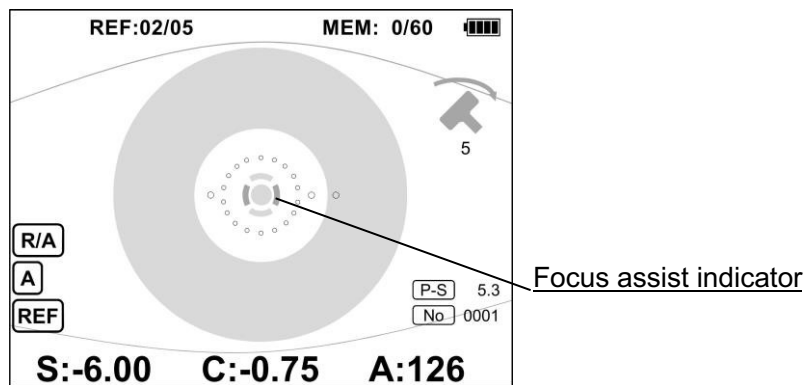

Measurement screen when focus assist is “ON” or “DISPLAY”

The display is made according to the distance between the device and the eye to be examined as follows.

setting	Distance between the device and the eye						
	far	←————→					close
ON							
	up and down: white	up and down: white	up and down: green	up and down: green	up and down: white	up and down: white	up and down: white
		right and left: blue	right and left: green	right and left: green	right and left: orange		
	not measuring		measuring			not measuring	
DISPLAY							
	up and down: white	up and down: green	up and down: green	up and down: green	up and down: green	up and down: green	up and down: white
			right and left: blue	right and left: green	right and left: orange		
	not measuring	measuring					not measuring
OFF							
	up and down: white	up and down: green	up and down: green	up and down: green	up and down: green	up and down: green	up and down: white
	right and left: white	right and left: green	right and left: green	right and left: green	right and left: green	right and left: green	right and left: white
	not measuring	measuring					not measuring

- 
 - This is an auxiliary function to obtain measured value at a more accurate position such as those who are not good at focusing the mire ring and for training purpose.
 - However the function is “ON” or “DISPLAY”, the examiner operates it, should be careful not to contact instrument to patient’s face.

4-4-4 Astigmatic Axis Correction Function



(1) Horizontal Correction Function

This is a function when the normal measurement, correct the astigmatic axis (AX) corresponding to the instrument inclination.

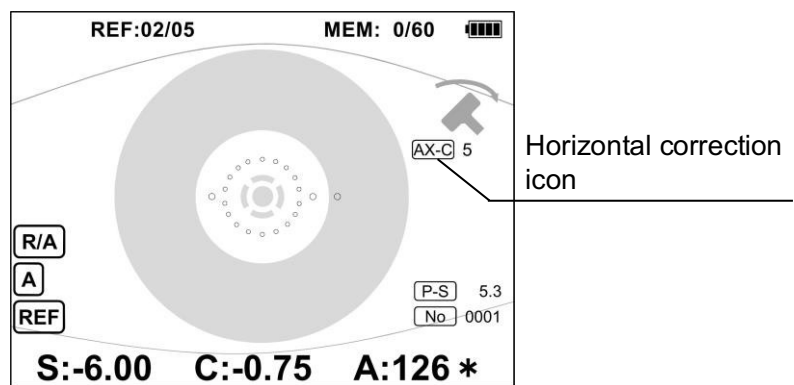
1. At the measurement standby screen, hold down  for 2 seconds.
2. "AX-C" is displayed next to horizontal indicator, and the measured value is corrected in 1° increments by the amount that the device is tilted. However, the horizontal indication display is displayed in 2° increments.



Measurement screen when horizontal correction is "ON"

3. When you wanted to release the auto correction, hold down  for 2 seconds again.
4. When tilted more than 90°, the automatic correction is canceled and the display "AX-C" disappears.
5. Enter to [SETUP] with  and set <PARALLEL> in [OTHER] to "OFF", the horizontal indicator icon can be hidden. In that state, hold down  for 2 seconds to display only "AX-C" and automatic correction is enabled.
6. When the angle is corrected by the horizontal correction function, the * mark is displayed in AX value.

[REF]		SPH	CYL	AX	P-S	CV
R	-	6.00	- 0.75	126 *	4.0	10
L	-	6.00	- 0.25	52 *	4.7	10

No	0001
VD	12.0
R AX	--
L AX	--

A
SAVE & SEND : SEND SW
EXIT : START SW

Measurement completed when horizontal correction is "ON"

-REF-			
[R]	SPH	CYL	AX
-	6.00	- 0.87	150 *
-	6.25	- 1.12	152 *
-	6.50	- 0.75	168 *
-	6.50	- 0.37	165 *

Printing example



 - Horizontal correction never function when the rotation correction function (as well as the icon).

(2) Rotation Correction Function of Instrument

If you need to perform measurement from 45°, 90°, or 135° rotated position, as for bedside measurement, astigmatic axis (AX) must be set appropriately. The rotation correction function corrects the astigmatic axis automatically from the rotated position.

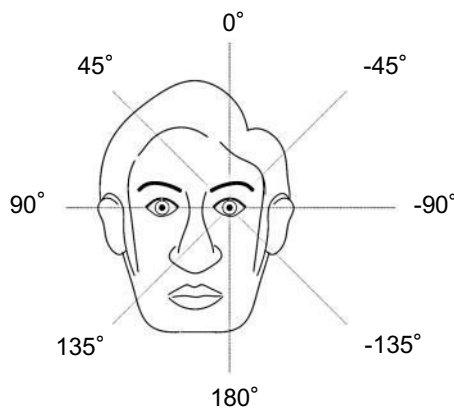
Set the automatic correction angle to suit the measuring position as illustrated below.



1. Hold down  on the operation panel for 2 seconds. The blinking arrow is displayed on the measurement screen and shift to the rotation corrected angle select screen. Corrected angle is displayed with "AX" on right side of the screen.
2. Press the measurement switch to change the rotation corrected angle. Each time you press that button, align the direction of the arrow with patient's head.
3. To be off rotation correction function, hold down  for 2 seconds again.

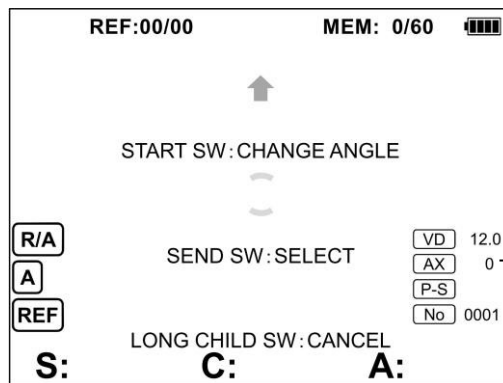

Rotation corrected angle

Rotation corrected angle select screen

4. Push , the arrow changes from blinking to lighting and completed to setting and goes to measurement standby mode. Push measurement switch, measurement starts.

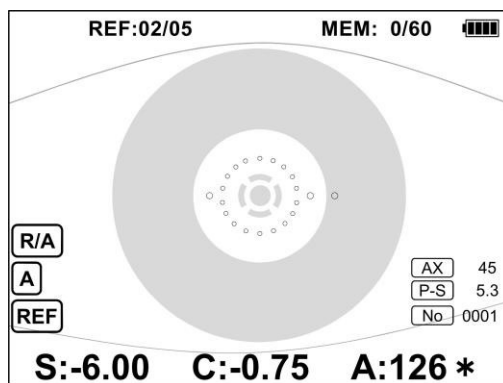

Measurement screen with rotation correction function

5. To release rotation correction function, hold down  for 2 seconds again.
6. When the angle is corrected by rotation correction function, * is displayed with AX value.

Each corrected angle for right/left eye measurement is displayed on measurement completed screen.

REF:05/05		MEM: 0/60		[RE]	
	SPH	CYL	AX	P-S	CV
R	- 6.00	- 0.75	126 *	4.0	10
L	- 6.00	- 0.25	52 *	4.7	10

[No]	0001
[VD]	12.0
[R] [AX]	45
[L] [AX]	45

[A]
SAVE & SEND : SEND SW
EXIT : START SW

Rotation corrected angle

Measurement completed screen with rotation correction function

-REF-			
[R]	SPH	CYL	AX
-	6.00	- 0.87	150 *
-	6.25	- 1.12	152 *
-	6.50	- 0.75	168 *
-	6.50	- 0.37	165 *

Printing example



- When rotation correction function is on, the discrimination of eye right/left automatically set to manual.
- Do not use forehead rest if rotation correction function is on. It possibly contact to the other eye or parts except forehead.

4-4-5 AUTO QUICK Mode

Refractive measurements may be difficult to obtain due to rapid eye movements in patients with nystagmus or children, or for other reasons. In such a situation, the AUTO QUICK mode function automatically activates the quick measurement mode which requires less time for measurement.

1. Enter to [SETUP] with , set <AUTO QUICK> in [OTHER] to "ON".
2. The case when the REF measurement cannot be executed after 6 seconds, shift to QUICK mode automatically.
3. When switching to QUICK mode, "AQ" is displayed on the left side of the screen.

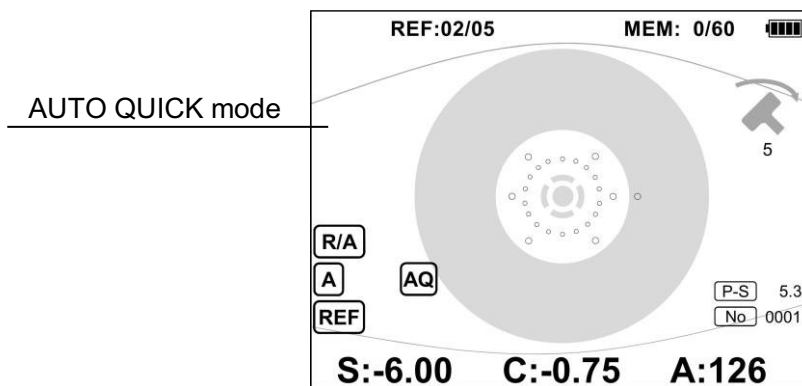

Measurement screen when switching to QUICK mode by AUTO QUICK mode

The AUTO QUICK mode is only enable at "AUTO measurement mode (A)" and "AUTO measurement mode 2(A2)". It is unable when "Continuous measurement mode (CONT)".

4. After entering QUICK mode by AUTO QUICK mode, it is automatically released under the following conditions.

Condition	
1	Measurement of one eye ends.
2	Measurement suspended by pressing measurement switch.
3	The right/left eye discrimination is switched.

5. When shifting to QUICK mode by AUTO QUICK mode, "AQ" is printed on the measured data.

-REF-			
[R]	SPH	CYL	AX
-	6.00	- 0.87	150
-	6.25	- 1.12	152
-	6.50	- 0.75	168 AQ
-	6.50	- 0.37	165 AQ

Printing example



- In the QUICK mode, refractive measurement takes about half the ordinary time, but measurement values tend to vary more widely.

4-4-6 Retroillumination Mode

In the case of “the measured value varies”, “the confidence value is low”, etc., there may be foreign substances that obstruct measurement light such as opacity of the lens. For such patients, you can observe the optic media by using “Retroillumination mode”.

1. Push  to shift to retroillumination mode.
2. Mire ring and background illumination (light illuminating the outer eye part such as the iris) lights. Then, position the patient eye to central.
3. Press the measurement switch, only measurement light is lighting and mire ring and background illumination are light out, only the central cornea reflected light and pupil can be seen. Any foreign objects, such as opacity in the crystal lens, that obstruct the measuring beam, appear as black shades on the screen.

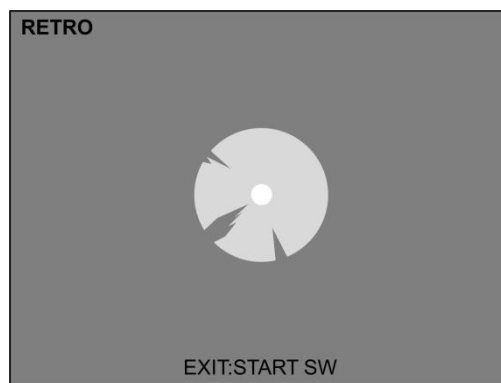

Observation of optical media by retroillumination mode

- A better view may result by shifting the image off center. In particular, an opacity existing in the center can only be seen by projecting light off the opacity.
 - Do not expose the patient's eye to external light (such as illumination from a fluorescent tube) as that may lead to deterioration of visibility.
4. Press the measurement switch to restore the condition given Step 2.
 5. Push  again to return the measurement standby mode.



▪ When the retroillumination mode, not implement the judgement of right/left eye.

4-4-7 Storing Data



This instrument stores data for 60 people (120 eyes).

Storable items

Data which can be stored in the memory		
REF measurement value	Value of pupil diameter	Dates
Patient No.	VD value	Measurement mode
CYL symbol		

(1) Memory function

When the memory function is on, the transferred data to the printer automatically stored to the main unit.

1. Hold down  for 2 seconds on measurement standby screen,  lights and memory function is on.
2. After measurement, when sending measurement data to the printer, the data is automatically stored in the main unit.

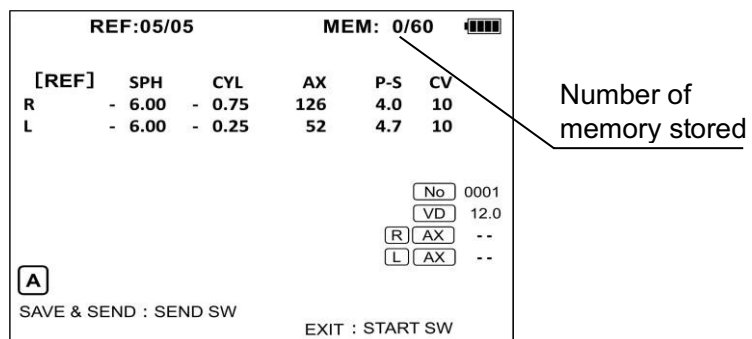

Measurement completed screen with memory function is on

3. If the data stored, the data added as above figure.

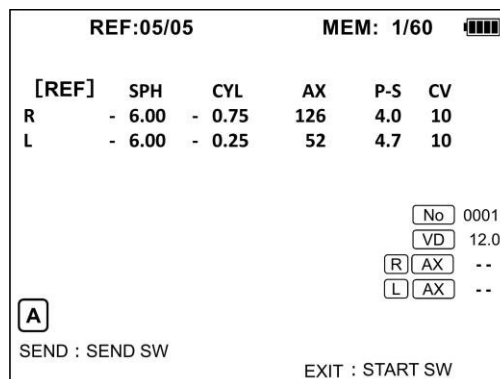

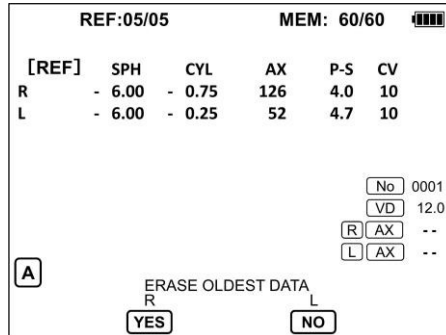

Measurement completed screen with the data is stored in the main unit

- When you stored data with maximum storage, the buzzer sounds and switches to the screen below.



Data is stored when memory is maximum

- Press , the oldest data is erased and the data is stored. Press , the data is not stored and sent to the printer.
- If you want memory function to be off, hold down  for 2 seconds on measurement standby screen again.

(2) Quick Saving

This function can manually save the measured data when the memory function is off.

- Implement measurement with the memory function off.
- Hold down  for 2 seconds when the measurement one side eye or both eyes completed, memory function indication appears on the screen, and the storage added.

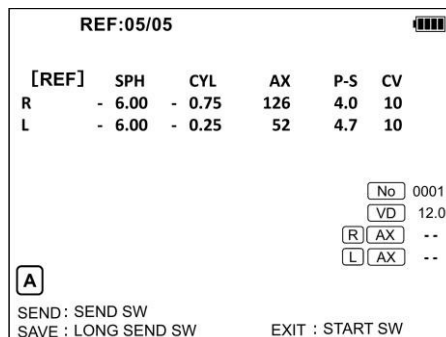

Measurement completed screen with memory function is off

- After pressed the measurement switch, move on to measurement standby screen. The memory function indication disappears.

4. Printing the data stored by quick saving, "QS" is printed on the printing data.

```
No. 12345
'18.07.20 03:30 PM
Name:
TYPE:AUTO      QS
VD:12.0
-REF-
[R] SPH      CYL  AX
<REP>
- 2.12 - 0.62 111
(S+C/2 = -6.62 )
X 4.2 y 4.1 CV:10
```

Printing example



- When you wanted to store only one eye's data, press  after measured one eye.
- The data never be stored repeatedly.

4-5 Printing

4-5-1 Printing Procedure

Print out the data transferring by IR rays from the instrument.



- If measurement mode is “CONT”, in case setting <OUTPUT DATA> in [OUTPUT] - [CONT FORMAT] with [SETUP] to “ALL”, an error will occur if data is transmitted while the main unit and the printer are separated by 50 cm or more. Be sure to transmit the distance between the main unit and the printer closed to less than 50cm. If <OUTPUT DATA> is set to “LAST5”, it can be transmitted even if it is more than 50cm apart.
- In the case of “transmitting stored data”, if <OUTPUT NUMBER> in [MEMORY] with [SETUP] is set to “LAST10”, “LAST30”, or “ALL”, an error occurs when the data is transmitted from 50cm or more apart. Be sure to transmit the distance between the main unit and the printer closed to less than 50cm. If <OUTPUT DATA> is set to “SELECT”, it can be transmitted even if it is more than 50cm apart.
- If an error occurs, bring the main unit closer to the printer and transmit again.

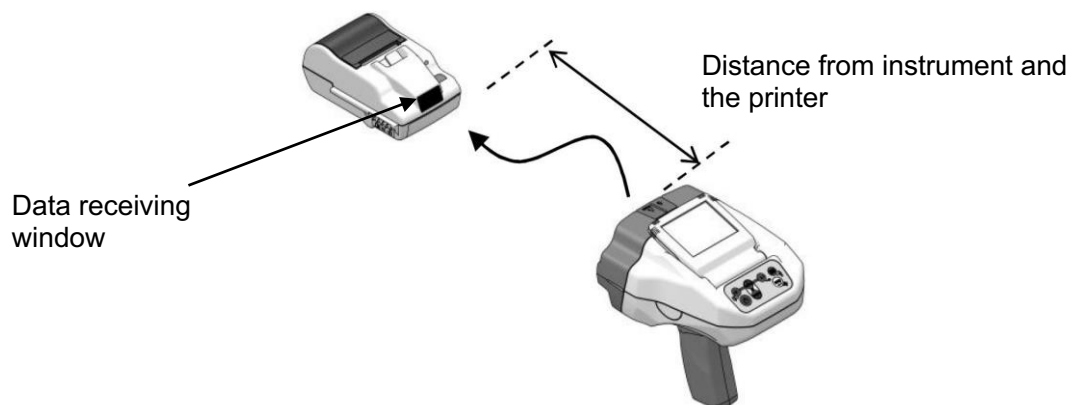

Measurement mode and data transmittable distance

Measurement mode	AUTO, AUTO2	CONT FORMAT “ALL”
	CONT FORMAT “LAST5”	
Distance between main unit and printer	Sending stored data “SELECT”	Sending stored data “LAST10 · 30”, “ALL”
Less than 50cm	○	○
50cm or more	○	×



1. Set the print roll correctly. (See “7-2 Replacing the Print Roll”)
2. Make sure the printer power on.
3. After the end of the measurement, press  toward the printer’s data receiving window, the measurement data successfully transferred.
4. The printer discharges print paper showing the measured value after transfer. The print content is output according to the setting of “5-2 Output setting screen [OUTPUT]”.



- The printer may fail to operate in the following situations:
 - ◆ The light from the main unit does not reach the printer when, for example, a person passes between the main unit and printer.
 - ◆ The printer is used at a place more than 6 m away from the main unit.
 - ◆ There is an angle of more than 45 degrees between the front side of the main unit and the data receiving window of the printer.
 - In such cases, move near the printer and press  once again to send data. Printout can be made as many times as necessary before the next measurement starts.
 - When measuring the next patient, be sure to make a printout before starting the measurement.
 - Retinomax Screen series cannot be used with a printer provided for use with Retinomax, Retinomax 2, or Retinomax 3.
 - If print paper runs out during printing, the indicator light blinks in pink. Replace the printing paper according to “7-2 Replacing the Print Roll”. After replacing printing paper, automatically reprint the data. After the indicator blinks in pink, data is deleted after 5 minutes without replacing the print paper.
- Please push  again and transmit measurement data.

4-5-2 Printing Examples

Patient No.	No. 1234	
Measurement date/time	'18.07.20 03:30 PM	
Measurement mode	Name:	Add name by hand writing as needed
VD value	TYPE:AUTO	
	VD:12.0	
	-REF-	
	[R] SPH CYL AX	
	- 6.00 - 0.87 150	
	X 4.2 y 4.1	Pupil diameter
	- 6.25 - 1.12 152	
	X 4.0 y 3.9	
Right eye	- 6.50 - 0.75 168	
REF + pupil diameter values	X 4.1 y 4.0	
	- 6.50 - 0.37 165	
	X 4.2 y 4.1	
	- 6.50 - 0.62 161	
	X 4.4 y 4.3	
	<REP>	
	- 6.25 - 0.75 161	
Right eye	(S+C/2 = -6.62)	Right eye
REF representative value	X 4.2 y 4.1 CV:10	Spherical equivalent power in representative value
Right eye	[L] SPH CYL AX	
Pupil size representative value	- 6.50 - 0.37 1	REF confidence value
	X 4.5 y 4.4	
	- 6.25 - 0.37 17	
	X 4.3 y 4.2	
	- 6.50 - 0.25 17	
Left eye	X 4.3 y 4.2	
REF + pupil diameter values	- 6.50	
	X 4.4 y 4.3	
	- 6.50 - 0.37 9	
	X 4.5 y 4.3	
	<REP>	
	- 6.50 - 0.75 9	
Left eye	(S+C/2 = -6.68)	Left eye
REF representative value	X 4.4 y 4.3 CV:10	Spherical equivalent power in representative value
Left eye	Retinomax Screen	REF confidence value
Pupil size representative value		
Message		

```

No. 1234
'18.07.20 03:30 PM
Name:
TYPE:AUTO
VD:12.0
-REF-
[R] SPH   CYL  AX
<REP>
  - 2.12 - 0.62 111
  (S+C/2 = -6.62 )
  X 4.2 y 4.1 CV:10

```

Eye print — eye print —

```

[R] SPH   CYL  AX
  -2.12 -0.62 111

```

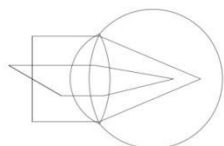

 - The measured values are always printed in order from the right to the left eye even when the left eye was measured first.

4-5-3 Cutting off the Printer Paper

Auto cutter is equipped on the printer and the paper is automatically cut.

Tear out the paper by pulling it toward you since the central of the paper is still tied.

 - If some trashes and chip from the paper on the thermal head or outlet of the printer, may cause printing error. Implement cleaning sometimes and keep

4-5-4 Using Multiple Printers

If two or more printers are available in the room, set the DIP switch of each printer as described below in order to avoid mutual interference.

To change the identification number of the printer, remove the battery cover and battery of the printer and operate the DIP switch. Please change the main unit identification number with <PRINT ID> in [OUTPUT SETTING], see “5-2-1 Output Setting [OUTPUTSETTING]”. If <PRINT ID> is set to <SELECT>, the screen switches to the <PRINT ID SELECT> screen each time when data is transmitted. Please select the PRINT ID set for the printer you want to send.

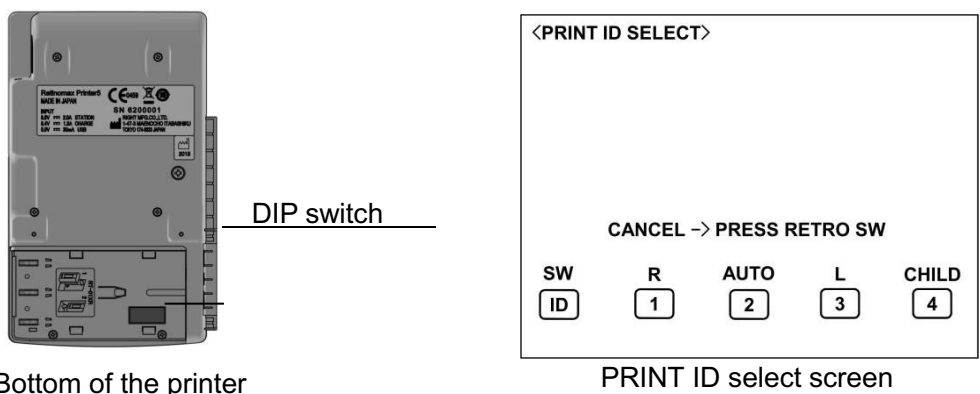

To change the identification number of the printer, operate the DIP switch according to the table below.

ID number	DIP switch of the printer setting	Operation method on the PRINT ID selection screen when the <PRINT ID> setting is "SELECT"
1		Press button
2		Press button
3		Press button
4		Press button

4-5-5 Change Setting by DIP Switch

The following settings are possible by operating the DIP switch.

DIP switch of the printer setting	Setting
<p>ON 1 2 3 4 5 6</p>	<p>Printer information is printed at power on. Measurement data will not be received, so return it for normal use before using it.</p>
<p>ON 1 2 3 4 5 6</p>	<p>Turn auto cut function off.</p>
<p>ON 1 2 3 4 5 6</p>	<p>Disables errors when printing paper runs out. Even if print paper runs out during printing, the indicator light not blinks in pink.</p>
<p>ON 1 2 3 4 5 6</p>	<p>Blank.</p>

4-6 Power off

After measurement, the main unit power off under the conditions following

- Press during measurement or measurement standby.
- Press in [SETUP].
- Hold down for 2 seconds with sub-menu in [SETUP].
- Hold down for 2 seconds and release in standby mode.
- Power off with the setting of Auto Power Off.
- Place the main unit to the station with power on.
- When the battery is low.

After use, turn off the power switch of the station and put the dustcover(accessory). Also, be sure to turn off the station at the end of the day's work.

After turning off the power of the main unit, please cover the main unit with a dust cover.

When covering the dustcover, please restore forehead rest and LCD screen. It may get caught when dropping the dust cover and cause it to fall.

If not use for long time, remove power cable and also remove the battery pack from the main unit and printer. If leave the power cable connected, the battery pack may deteriorated or cause of fire.

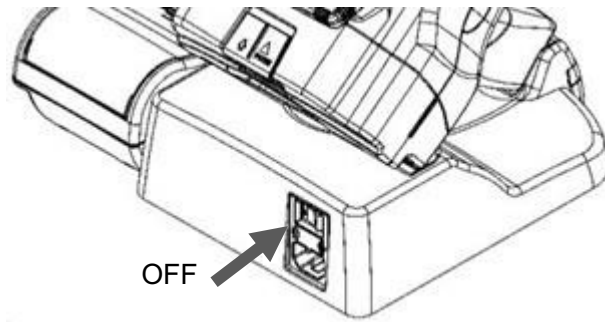

4-7 The Other

4-7-1 For Proper Measurement

▼ If the right/left eyes are not properly discriminated

• To ensure proper operation of the automatic right/left eye discrimination, note the following:

- When extending your hands between the patient's face and the main unit to stabilize the main unit, do not touch the right/left eye sensors.
(See "2-1 Main Unit")
- Take measurement squarely in front of the patient's face as shown below. The discrimination may fail if measurement is taken at an angle upward or sideways.

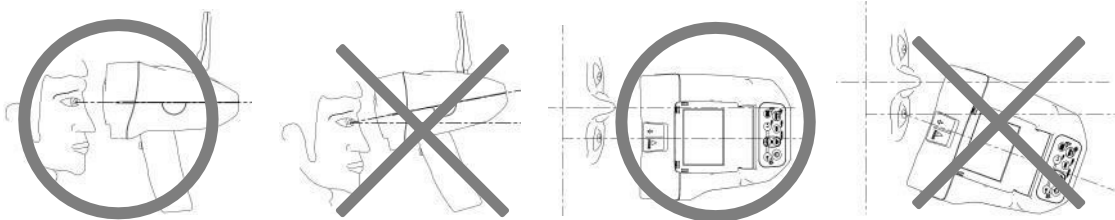









- If you follow the above main unit but the right/left eye discrimination still does not work properly (for example, the measuring window is brought near the left eye, but the right/left eye indicator remains "R"), switch to the manual right/left eye discrimination.

The right/left eye discrimination can fail if:

- The patient is wearing a mask.
- The patient has a great deal of hair on either cheek.
- The face is small, in the case of a child or baby.



- Switching to manual eye discrimination is also required when taking measurement from above the head or at an angle sideways or

- Switching from automatic right/left eye discrimination mode to manual mode.
 - Pressing  or   to switch to manual mode ( lights off).
 - When you wanted to measure right eye, press  and indicated right eye and  symbol turns on.
 - When you wanted to measure left eye, press  and indicates left eye and  symbol turns on.
- If you want to restore the automatic right/left eye discrimination, press  to return automatic discrimination and the symbol turns on.

4-7-2 Auto Fogging

The auto fogging function minimizes the patient's eye accommodation. The instrument automatically enters the fogging state when measurement starts. Be sure to tell the patient to look at the fixation target. Auto fogging method is different in A mode, A2 mode and QUICK mode.

<A mode>

- (1) Press the measurement switch and perform preliminary measurement.
↓
- (2) Fixation chart moves to the position where it is in focus.
↓
- (3) Fixation chart moves far (Fogging). Fixation target appears blurred to the patient.
↓
- (4) Obtain data for 5 times. When data is obtained, a “beep” sound is made. Fixation chart remains in fogging state, and the appears blurred to the patient.
↓
- (5) If stable data is obtained, measurement is finished.
↓
- (6) If the measured values are fluctuating, go back to (2), fixation chart moves to the position where it is in focus and moves again to the far side.
↓
- (7) Obtain new data for 3 times.
↓
- (8) Repeat movement of fixation chart and data obtainment for 3 times until the measured value is stabilized.

The main unit stores up to 8 times of data. If more than 8 data are obtained, the oldest data will be erased in order.

<A2 mode>

- (1) Press the measurement switch and perform preliminary measurement.
↓
- (2) Fixation chart moves to the position where it is in focus.
↓
- (3) Fixation chart moves far (Fogging). Fixation target appears blurred to the patient.
↓
- (4) Obtain data for 1 time. When data is obtained, a “beep” sound is made. Fixation chart remains in fogging state, and the appears blurred to the patient.
↓
- (5) After a data is obtained, fixation chart moves to the position where it is in focus again and moves again to the far side to obtain data for 1 time.
↓
- (6) Repeat movement of fixation chart and data obtainment for 5 times and measurement is finished if stable data is obtained.
↓
- (7) If the measurement values are fluctuating, repeat movement of fixation chart and 1 data obtainment for 3 times until the measured value is stabilized.
The main unit stores up to 8 times of data. If more than 8 data are obtained, the oldest data will be erased in order.

<A mode QUICK>

QUICK mode in A mode, the measurement time is shortened by using different fogging method from ordinary A mode and A2 mode.

- (1) Press the measurement switch and perform preliminary measurement.
↓
- (2) Fixation chart moves far (Fogging). Fixation target appears blurred to the patient.
↓
- (3) Repeat data obtainment until the measurement value is stabilized.
The main unit stores up to 8 times of data. If more than 8 data are obtained, the oldest data will be erased in order.

In A2 mode, measurements are performed in the same way as in normal A2 mode even in QUICK mode.

4-7-3 Representative Value

Representative values are median values of the measurement. The value indicated as <REP> in the printed data is the representative value. For example of printing, see “4-5-2 Printing Examples”.

Confidence value (CV) is printed as the representative value. The smaller the variation, the closer confidence value is to 10.

4-7-4 REF Confidence Value

Confidence Value (CV) indicates the variation between measurement results. Only when the measurement is performed more than 3 times, “CV: OO” will be indicated on the measurement completion screen and printed on the data result. For example of printing, see “4-5-2 Printing Examples”. If measurement is performed less than 3 times, “—” is indicated. Please use the following as a guide for confidence value.

- 8 or higher :Low variation.
- 7 or lower :High variation. Care is needed in interpreting the measurement results.
Please measure again with focus assist function or confirm the variation of measurement value with CONT mode.

If measured values vary widely, such as in refractive measurement, and you want to select one from among them, note the following tips:

- The patient may not be staring central of the target.
- Eyelashes are hanging over the pupil.
- The patient’s pupil size is small.
- Eye disease such as turbidity of the optical media.
- If only SPH value vary widely, the patient's eye may be accommodating. Measure the same eye once again.
- When CYL indicates weak astigmatism (below 0.5D), AX tends to be somewhat unstable.

In the above cases, the confidence value is typically low.

If eyelashes or pupil size are the cause, correct the problem and retry the measurement.

4-7-5 Standby Mode and Auto Power off

If measurement is not performed, if the switch operation is not performed for a certain time, it will automatically shift to the standby mode. Furthermore, the power turns off automatically when a certain time passes in standby mode.

To return from the standby mode, press the measurement switch or .

It is possible to edit time to shift to standby mode and to turn off the power with [POWER OPTION] in [SETUP]. (See “5-7 POWER OPTION Screen [POWER OPTION]”)

It never switch to standby mode during measurement.

4-7-6 Measurement of IOL Eyes

This instrument can measure an IOL (intraocular lens) implanted eye in the same process as the normal eye without any special switch setting. Depending the type of IOL or the condition of the IOL eye, the reflecting light from the IOL may disable the measurement, lead to a degradation of the confidence value of measured values, or result in larger measurement errors.

- If it is difficult to obtain measurements, using the Quick Mode may make the measurement easier.
- If the auto quick function is set beforehand, it automatically changes to “Quick Mode” (See “4-4-5 AUTO QUICK ”) only when the measurement is difficult to perform, thus allowing you to perform measurement.

4-7-7 If Measured Values are not Obtained

Normally, measured values should be displayed when they are obtained. If they are not obtained even when the instrument is aligned, there may be an unusual condition. Here are some workarounds.

- For a patient with drooping eyelashes, the eyelashes must not be within the outer contours of the alignment mark on the screen. Ask the patient to open the eyewider, and if eyelashes are still drooping, you may have an assistant or the patient lift the upper eyelid lightly with a fingertip.
- Measurement may be impossible if the patient has an eye disease such as cataract; opacity in the cornea, crystal lens, or vitreous body, or retinal detachment.
- Measurement cannot be made if <SPH+CYL> is out of the measurement range of -18D to +23D, or if <CYL> is out of the measurement range of 0D to ± 12 D.

- Measuring an eye with a contact lens.

Measurements can usually be obtained. However, if the contact lens is not properly fitted, correct values may not be obtained. Dirt or scratch on the contact lens may hinder measurement.

5. Setting Up the Instrument

At measurement screen, pressing both of  moves into SETUP screen and possible to edit each of setting.



[SETUP]	18. 06. 15 3:30 PM
[EXIT]	
[MEASURE]	[POWER OPTION]
[OUTPUT]	[PATIENT No]
[MEMORY]	[MESSAGE]
[CHILD]	[INITIAL]
[OTHER]	[VERSION]
[CLOCK]	
UP : AUTO SW DOWN : RETRO SW RIGHT : L SW LEFT : R SW SELECT : SEND SW	

EXIT	Moves to the measurement screen.
MEASURE	To "5-1 Measurement Setup [MEASURE]".
OUTPUT	To "5-2 OUTPUT Screen [OUTPUT]".
MEMORY	To "5-3 MEMORY Screen [MEMORY]".
CHILD	To "5-4 CHILD Mode Screen [CHILD]".
OTHER	To "5-5 OTHER Setting [OTHER]".
CLOCK	To "5-6 CLOCK Screen [CLOCK]".
POWER OPTION	To "5-7 POWER OPTION Screen [POWER OPTION]".
PATIENT No	To "5-8 Patient Number Setup [PATIENT No]".
MESSAGE	To "5-9 MESSAGE Screen [MESSAGE]".
INITIAL	To "5-10 INITIALIZING Screen [INITIAL]".
VERSION	To "5-11 VERSION Confirmation [VERSION]".

■Select items: during focusing on the items, the characters switch to yellow color.

With , select items on the screen.

Press  to enter into sub menu and select setting items. In sub-menu, select setting

items with  and change setting with . Select "EXIT" and press  in sub-menu, the content stored and goes back to previous screen. Select "EXIT" and press

 in [SETUP] to retrun to measurement standby screen.

5-1 Measurement Setup [MEASURE]

Use this screen to configure setting that work during measurement.

[MEASURE]		
[EXIT]		
<TYPE>	:	AUTO
<P-S>	:	ONE
<CYL>	:	-
<VD>	:	12.0
<STEP>	:	AUTO
UP : AUTO SW DOWN : RETRO SW SELECT : L SW SELECT : R SW SELECT (EXIT ONLY) : SEND SW		

Item	Selection	Setting
EXIT	-	Back to the [SETUP] screen.
TYPE	AUTO	Switches to AUTO mode.
	AUTO2	Switches to AUTO2 mode.
	CONT	Continuous measurement mode.
P-S	ONE	Measuring pupil diameter once with REF measurement.
	ALL	Measuring pupil diameter each time with REF measurement.
	OFF	Not measuring the pupil diameter.
CYL	MIX	Without CYL measurement value conversion.
	-	Converts CYL value to minus.
	+	Converts CYL value to plus.
VD	12.0	Sets corneal vertex distance (VD) in mm.
	13.5	
	13.75	
	15.0	
	16.0	
STEP	AUTO	Display the measurement value in 0.12D steps if measurement value within $\pm 3D$. The other displays in 0.25D steps.
	0.25	Display the measurement value in 0.25D steps.
	0.12	Display the measurement value in 0.12D steps.

5-2 OUTPUT Screen [OUTPUT]

Use this screen to configure external output setting.

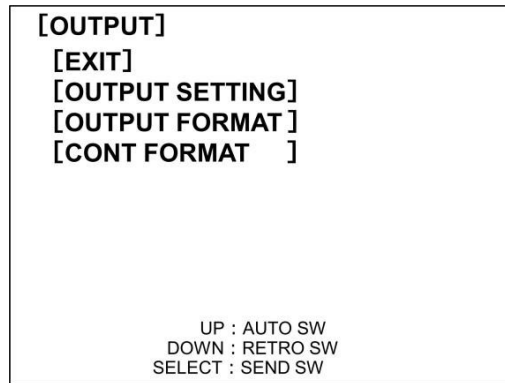

EXIT	Back to the [SETUP] screen.
OUTPUT SETTING	To "5-2-1 Output Setting [OUTPUT SETTING]".
OUTPUT FORMAT	To "5-2-2 Output Format [OUTPUT FORMAT]".
CONT FORMAT	To "5-2-3 Output Format of CONT Measurement [CONT FORMAT]".

5-2-1 Output Setting [OUTPUT SETTING]

Make settings related to data output from the printer when sending data from the main unit to the printer. Also, set the printer's PRINT ID.

[OUTPUT SETTING]	
[EXIT]	
<OUTPUT>	: PRINT & USB
<PRINT ID>	: 1
<USB FORMAT>	: PC
UP : AUTO SW DOWN : RETRO SW	
SELECT : L SW SELECT : R SW	
SELECT (EXIT ONLY) : SEND SW	

Item	Selection	Setting
EXIT	-	Back to the [OUTPUT] screen.
OUTPUT	PRINT ONLY	Implement print only.
	PRINT & USB	Implement printing and transfers data to PC via USB.
	USB ONLY	Implement only transferring the data to PC via USB.
PRINT ID	1	Set the Printer ID No.
	2	
	3	
	4	
	SELECT	Select PRINT ID No. before transferring the data.
USB FORMAT	PC	Output the ASCII format data to PC.
	CSV	Output the CSV format data to PC.

5-2-2 Output Format [OUTPUT FORMAT]

Set the format of the data output from the printer.

[OUTPUT FORMAT]		
[EXIT]		
<REF>	:	ALL
<P-S>	:	ON
<MESSAGE>	:	OFF
<EYE>	:	OFF
UP : AUTO SW DOWN : RETRO SW		
SELECT : L SW SELECT : R SW		
SELECT (EXIT ONLY) : SEND SW		

Item	Selection	Setting
EXIT	-	Back to the [OUTPUT] screen.
REF	ALL	Printout all of measurement data(maximum is 8) and representative value.
	REP	Printout only representative value.
	OFF	Not printout REF value.
P-S	ON	Printout pupil diameter.
	OFF	Not printout pupil diameter
MESSAGE	ON	Printout message.
	OFF	Not printout message.
EYE	ON	Printout eye print.
	OFF	Not printout eye print.

5-2-3 Output Format of CONT Measurement [CONT FORMAT]

This enables you to output in different contents from the normal CONT measurement.

[CONT FORMAT]	
[EXIT]	
<OUTPUT DATA>	: LAST5
<REF>	: ALL
<P-S>	: ON
<MESSAGE>	: OFF
UP : AUTO SW DOWN : RETRO SW	
SELECT : L SW SELECT : R SW	
SELECT (EXIT ONLY) : SEND SW	

Item	Selection	Setting
EXIT	-	Back to the [OUTPUT] screen.
OUTPUT DATA	LAST5	The last 5 data of REF measurement values are output.
	ALL	Output all REF measurement values. Up to 100 data can be output.
REF	ALL	Output REF measurement value and representative value set with <OUTPUT DATA> are output.
	REP	Printout only representative value.
	OFF	Not printout REF value.
P-S	ON	Printout pupil diameter.
	OFF	Not printout pupil diameter.
MESSAGE	ON	Printout message.
	OFF	Not printout message.

5-3 MEMORY Screen [MEMORY]

It sends data stored in the main unit to the printer and prints out / outputs to the PC. Also enable to erase stored data.

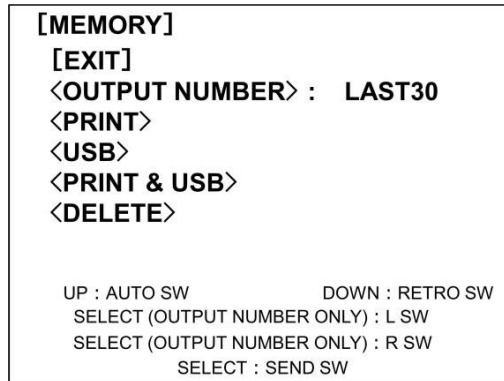

Item	Selection	Setting
EXIT	-	Back to the [SETUP] screen.
OUTPUT NUMBER	ALL	Transfer all stored data.
	SELECT *1	Transfer data which selected.
	LAST 10	Transfer 10 latest person's data at maximum.
	LAST 30	Transfer 30 latest person's data at maximum.
PRINT	—	Printout the stored data. The number of transfer depends on which you set at <OUTPUT NUMBER>.
USB	—	Output stored data by USB. The number of transfer depends on which you set at <OUTPUT NUMBER>.
PRINT & USB	—	Output stored data by printing and USB. The number of transfer depends on which you set at <OUTPUT NUMBER>.
DELETE *2	—	Delete the stored data.

*1 Stored data can be selected before transferring by setting at SELECT, <PRINT>, <USB>, <PRINT & USB>.

1) Stored data can be selected when the screen indicated [MEMORY NUMBER SELECT].

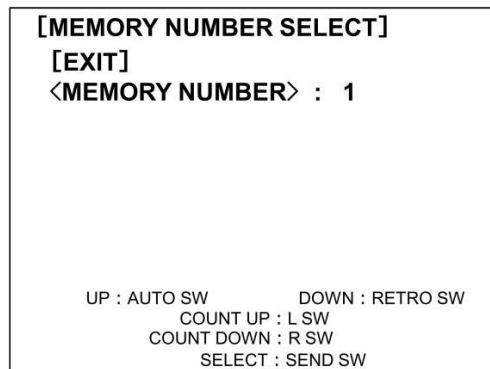

2) After select the data, screen indicates measurement completed when you press .

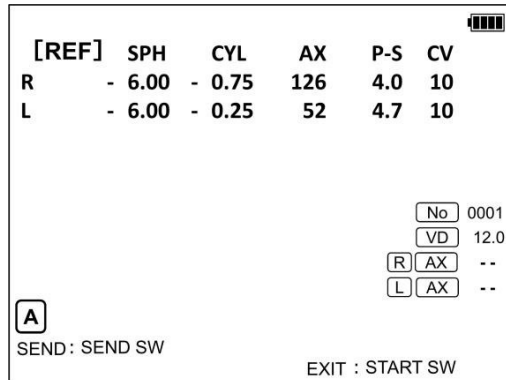

3) The data transferred when you press  again.

4) When you press the measurement switch, it goes back to [MEMORY NUMBER SELECT].

*2

After selected <DELETE>, screen indicates confirmation.

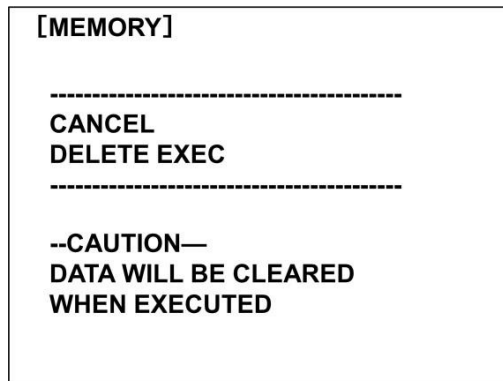

If selected "DELETE EXEC" and press , only the measurement data will be deleted.

5-4 CHILD Mode Screen [CHILD]

Implement setting of CHILD mode.

[CHILD]		
[EXIT]		
<MELODY>	:	ON
<LED>	:	ON
<CHART COLOR>	:	ON
UP : AUTO SW	DOWN : RETRO SW	
SELECT : L SW	SELECT : R SW	
SELECT (EXIT ONLY) : SEND SW		

Item	Selection	Setting
EXIT	-	Back to the [SETUP] screen.
MELODY	ON	Melody is made at CHILD mode.
	OFF	Melody isn't made at CHILD mode.
LED	ON	LED at peripheral measurement window lights at CHILD mode.
	OFF	LED at peripheral measurement window doesn't light.
CHART COLOR	ON	Varies color of fixation target background at CHILD mode.
	OFF	The color of fixation target background never changes at CHILD mode.

5-5 OTHER Setting [OTHER]

This setting effects while you measuring.

[OTHER]	
[EXIT]	
<BUZZER>	: ON
<ALIGN>	: OFF
<CHART BRIGHTNESS>	: AUTO
<LCD>	: 80%
<PARALLEL>	: ON
<FOCUS ASSIST>	: ON
<AUTO QUICK>	: OFF
UP : AUTO SW	DOWN : RETRO SW
SELECT : L SW	SELECT : R SW
SELECT (EXIT ONLY) : SEND SW	

Item	Selection	Setting
EXIT	-	Back to the [SETUP] screen.
BUZZER	ON	Enable buzzer beeps in operating and measuring.
	OFF	Disable buzzer beeps.
ALIGN	ON	Displays the alignment direction marks on the screen.
	OFF	Disappears the alignment direction marks from the screen.
CHART BRIGHTNESS	HIGH	Brighten the fixation target.
	LOW	Darken the fixation target.
	AUTO	Brightness of target automatically changes. If pupil diameter is over $\Phi 3\text{mm}$ →HIGH. Within $\Phi 3\text{mm}$ →LOW.
LCD	5 to 100%	Adjust brightness of the LCD.
PARALLEL	ON	Display the horizontal indicator.
	OFF	Disappears the horizontal indicator.
FOCUS ASSIST	ON	Display focus assist icon. Measurement is performed only when the focus is correct.
	DISPLAY	Only display focus assist icon.
	OFF	Disable focus assist function.
AUTO QUICK	ON	Enable AUTO QUICK mode.
	OFF	Disable AUTO QUICK mode.

5-6 CLOCK Screen [CLOCK]

Set time of the internal clock.

[CLOCK]

[EXIT]

<DATA FORMAT> : **YMD**

<TIME FORMAT> : **AM/PM**

18.11.26 03:30 PM

UP : AUTO SW DOWN : RETRO SW

 SELECT (FORM) : L SW



 SELECT (FORM) : R SW

 COUNT UP (NUMBER ONLY) : L SW

 COUNT DOWN (NUMBER ONLY) : R SW

 SELECT (EXIT ONLY) : SEND SW

Item	Selection	Setting
EXIT	-	Back to the [SETUP] screen.
DATE FORM	YMD(year/month/day)	Changes the date print format.
	MDY(month/day/year)(D)	
	DMY(day/month/year)	
TIME FORM	AM/PM(12-hour system)(D)	Changes the time print format.
	24-hour system	





Select the year, month, day, hour, minute with the  and , and make the respective

settings with the  and .

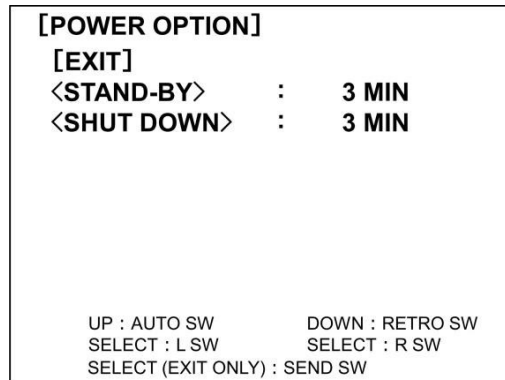
5-7 POWER OPTION Screen [POWER OPTION]

Set the time to enter standby mode and the time to turn off automatically.



Item	Selection	Setting
EXIT	-	Back to the [SETUP] screen.
STAND-BY	1 to 9 MIN NEVER	Set time to switch into standby mode. Press  button to add 1 minute. Press  button to minus 1 minute.
SHUT DOWN	1 to 9 MIN NEVER	Set time to shut down from standby mode. Press  button to add 1 minute. Press  button to minus 1 minute.

5-8 Patient Number Setup [PATIENT No]





Use this screen to set the patient number. The valid range is from 0000 to 9999.

[PATIENT No]

[EXIT]
<RESET>

No.0001

UP : AUTO SW DOWN : RETRO SW
 COUNT UP (NUMBER ONLY) : L SW
 COUNT DOWN (NUMBER ONLY) : R SW
 SELECT (EXIT AND RESET) : SEND SW

Item	Selection	Setting
EXIT	-	Back to the [SETUP] screen.
0001	0 to 9	Sets the 1st digit. key adds one.  key subtracts one.
0010	0 to 9	Set the 10th digit. key adds one.  key subtracts one.
0100	0 to 9	Sets 100th digit. key adds one.  key subtracts one.
1000	0 to 9	Sets 1000th digit. key adds one.  key subtracts one.
RESET	-	 key resets the number to 0001.

The factory default is 0001. When outputting data after measuring, the patient No. automatically increments by “1”.

5-9 MESSAGE Screen [MESSAGE]

This screen adds a message to the end of the printout. Move to the message input screen.

The message can be as long as 24 characters by 2 lines, or 48 characters in total.



[MESSAGE]

[EXIT]

A	B	C	D	E	F	G	H	I	J
K	L	M	N	O	P	Q	R	S	T
U	V	W	X	Y	Z	_	.	-	/
0	1	2	3	4	5	6	7	8	9
()	#	\$	-	?	!	%	*	+

INPUT : START SW BS : CHILD SW
 UP : AUTO SW DOWN : RETRO SW
 RIGHT : L SW LEFT : R SW
 SELECT (EXIT ONLY) : SEND SW

How to enter and set a message

Button	Operation
	Move the cursor relative position.
Measurement switch	Enter the character at the cursor.
	Delete the previously entered character.
	Press it after selected [EXIT], the entered message memorized and back to the [SETUP] menu.

5-10 INITIALIZING Screen [INITIAL]

If you select [INITIAL] at [SETUP] screen, message appears on the screen. When you selected "GO", confirmation message on the screen. Press "INITIAL EXEC", initialize all data in the [SETUP] and clears memory. After completed, "FINISHING INITIALIZATION" on the screen in 3 sec, and goes back to [SETUP] screen.

If you do not implement it, press "CANCEL" and goes back to [SETUP] screen.

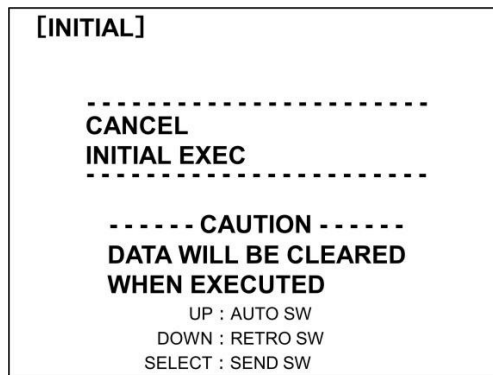
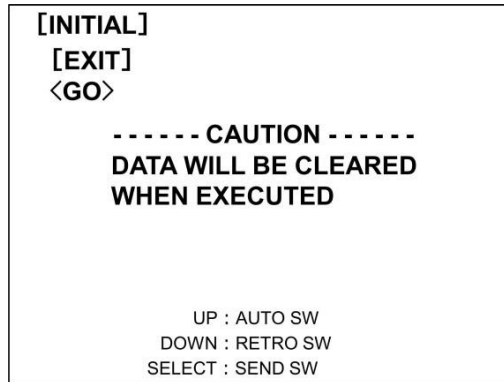

5-11 VERSION Confirmation [VERSION]

[VERSION] can check the software version. Select <PRINT & USB>, the main unit toward to

the printer and press  to print the software version of the main unit and the software version of the printer. Select [EXIT] to return to [SETUP].

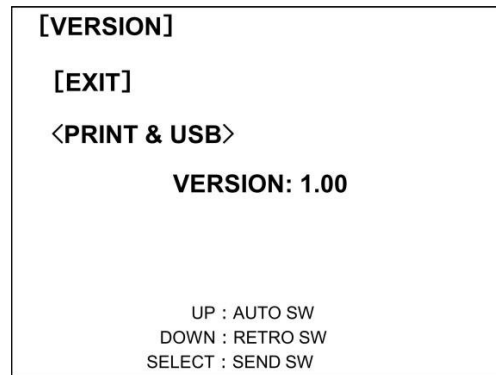

6. Connecting to External Instruments

The main unit and the printer have USB connectors for linking to external equipment. Measurement results can be sent via these connectors to external equipment such as a commercially available PC.

6-1 Wireless Transmission to the Remote Vision RV-II

When Remote Vision RV-II is used, it can receive data wirelessly using the infrared communication feature of the instrument. Press  by confront with receiving window and transmission window.

During the communication, make sure that there is nothing to disturb.

If there were something disturbs the communication, adjust the range and angle between Retinomax Screen and Remote Vision RV-II, the case of environment they positioned.

In order to wirelessly transmit to RV-II, it is necessary to upgrade RV-II. When upgrading RV-II, please contact the place of purchase.

6-2 Connecting to Computer via USB

Connect to computer with USB cable (A-micro B type connector).

Utilize the micro B type connector on the instrument's side.

When you output data to computer, see "5-2-1 Output Setting [OUTPUT SETTING]", set [OUTPUT] to "PRINT & USB" or "USB ONLY".

And, setup the list that necessary to external communication following.

Selection	Setting
Baud rate	115,200bps
Data	8bit
Parity	none
STOP bit	1bit
Flow Control	none

*Connecting cable sales at market. Utilize the size within 3 meter.

For more details on this interface, contact to your dealer.



- If a failure occurs in the USB port on the PC side, data may not be received. Please reconnect on the PC.

7. Maintenance

7-1 Checking the Measurement Accuracy

Check the measurement accuracy every time before using the equipment using the model eye provided. For the measurement method using model eye and the accuracy check method, see “4-1-4 Measuring the Model Eye”.

7-2 Replacing the Print Roll

When the print paper nears the end of the roll, red lines appear on both edge of the paper. This indicated that it is time to replace the paper roll. The print paper should be one designated by the manufacturer.

1. Push the release lever on the printer and open the paper cover (①).

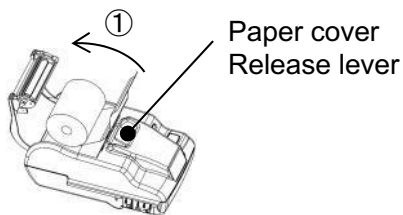

2. Remove the remaining print roll.
3. Remove the shipping tape from the new print roll.
4. Put a crease slightly past the peel mark.

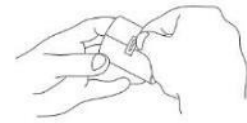

5. Gently cut the paper along the crease.
Cutting out the paper as shown on the right prevents accidental printing on the peel mark. Also the paper is easier to install.
6. Set the roll along the guide, as shown below, and press down the print roll as you close the paper holder cover.

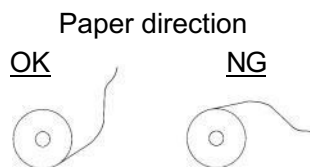
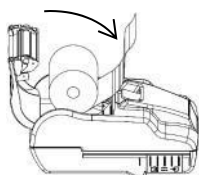
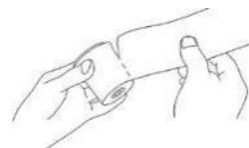

7. If you set the roll with power on, extra paper automatically cut. When the power off, the extra paper will not cut. If you press and hold the power switch for 3 seconds to turn on, the extra paper automatically cut.
8. Verify that the printer paper comes straight out.
If it comes out askew, remove the paper holder cover and set the roll again.



- Do not set the print roll upside down, as this makes printing impossible.
- Once the roll is set in place, do not force the paper out. Damage to the printer may occur.

 **CAUTION**

- Printer cutter is located in the place person never be touched, it is equipped with metal, careful not to be injured when replacing print paper.
- Do not touch the printer head when replacing the print paper. The printer head may be hot surface.

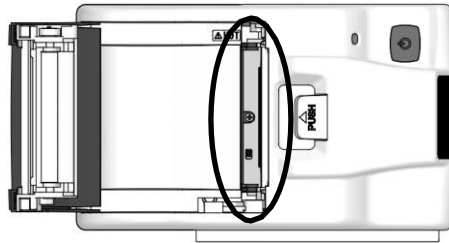

7-3 Replacing the Fuses

 **CAUTION**

- Before checking or replacing the fuses, be sure to turn off the power switch and remove the power cord from the receptacle outlet.
- Only use fuses as specified below. Other fuses must NOT be used.
- For spare fuses, contact your local dealer.

Littelfuse's time-lag fuse, $\phi 5 \times 20$ mm
250V/T1.6AH (021501.6XP)

If the power lamp does not light up when the power switch of the station is set to ON ("I" position), the fuses may have blown.

Remove the fuse holder by applying a small flat-blade screwdriver or other tool to the tabs on both sides of the fuse holder.

Remove the two fuses from the fuse holder and check if they have blown. Replace the fuses if blown.

Spare fuses are in the accessory case. See "2-3 Station".

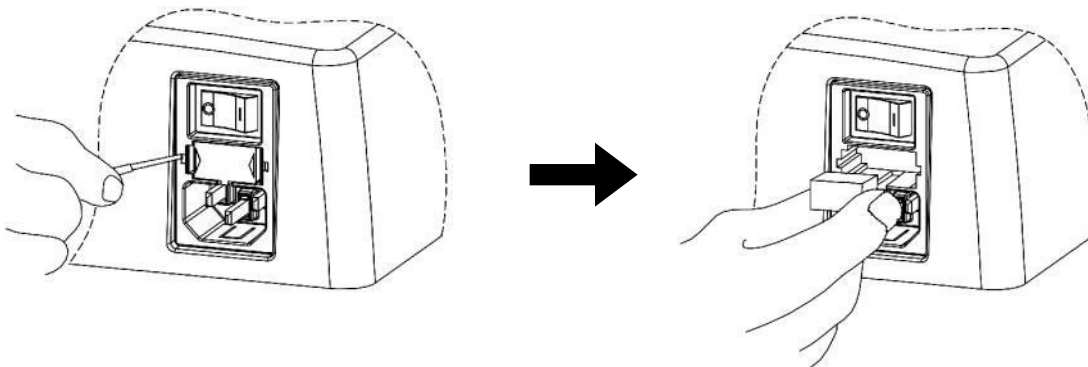

7-4 Cleaning the Forehead Rest

Cleaning should be done before the measurement. Clean the forehead rest with soft cloth, etc. soaked with rubbing alcohol.

7-5 Cleaning the Measurement Window

The measuring window has dust-proof glass. If any dust on the glass is visible from the patient side, blow off the dust three to four times using the blower provided. If the dust cannot be removed, wipe off using a lens cleaning solution or absolute alcohol (commercial product).



- Do not put heavy pressure on the dust-proof glass during wiping since the glass is thin and easily broken.

7-6 Cleaning Model Eye

When correct measured values cannot be obtained with the model eye, its lens surface may have been contaminated by dust or fingerprints. In this case, gently wipe the lens surface using a soft, clean cotton cloth (such as gauze) moistened slightly with lens cleaning solution or ethyl alcohol for disinfections, being careful not to scratch the surface. Do not use a handkerchief or absorbent cotton.



- Even a microscopic scratch on the lens surface of the model eye can reduce the accuracy of its measurement. Do not bump or throw any harm objects

7-7 Cleaning Appearance

If the appearance stained, wipe off with soft cloth, or the case that stubborn stains on the appearance, wipe off lightly with a gauze moistened slightly with diluted neutral detergent. As protection, utilizing dustcover on the instrument after measurement is recommended.



- Do not use organic solvent (alcohol, ether, paint thinner, etc.) on painted surfaces, plastic components, and printed surfaces. It may cause

7-8 List of Consumable and Maintenance Parts

Part name	Part number	Remarks
Print paper rolls(5)	DXA30109	Width 58mm Diameter 48mm
<Fuses> Littlefuse's time-lug fuses	021501.6XP	Rating 250V 1.6A Size $\phi 5 \times 20$ mm
Battery pack	RT-10XR	Lithium ion battery

7-9 Lifetime of the Instrument

Expiration date of this instrument is 8 years except consumable parts and the parts has expiration date. It varies depends on their environment, and using condition. Please contact to dealer or our company about maintenance.

8. Troubleshooting

Check with following table before calling for repair.

8-1 Main Unit

Phenomenon	Check point	Cause and action
The power lamp does not light when Retinomax is turned on. The monitor screen does not turn on.	Is Retinomax immediately afterwards purchase? Or is Retinomax used for a long period of time?	The battery pack is not charged when purchased. It may be fully discharged if Retinomax is not used for a long time. Charge the battery pack.
	Is the main unit set on the station?	When put on the station and start charging, the power turns off.
The screen switches off automatically.	Does the power symbol lighting?	The instrument is possibly in the Standby mode. See "4-7-5 Standby Mode and Auto Power off".
	Is the grip cover equipped properly?	This screen switches off automatically when the grip cover came out. Equip the grip cover properly.
The power switches off automatically.	Has the main unit been left inoperative for a long time?	The Auto power off is possibly working. See "4-7-5 Standby Mode and Auto Power off".
	Does the power symbol has been blinking with the color orange?	The case that battery being low, instrument automatically switches off. Charge the battery.
	Are the batteries charging contacts (4 places) dirty? (See "2-1 Main Unit")	Turn the power off, and clean the pins both on the main unit and the station sides.
	Is the main unit charging?	When put on the station and start charging, the power turns off.
Charging is not started even if the main unit is set on the station.	Is the main unit set firmly in the station?	Set main unit firmly in the station.
	Is the contact (4 places) dirty?	If touching the contacts (4 places) or getting dirty, wipe it off with a dry cloth.
The battery pack cannot be installed in the main unit	Is the battery pack in the correct orientation?	Check to make sure the battery pack is correctly installed. See "3-2 Installing and Removing the Battery Pack".
Refractive measurement cannot be made. Refractive measurements vary widely.	Is the measurement out of range?	If S and C are out of measurement range, measurement cannot be performed.
	Is there foreign matter in the pupil that obstructs light?	Check in the retroillumination mode. See "4-4-6 Retroillumination Mode".
	Does the patient staring at central of the target?	Give them an explanation to stare at central.
	Is the VD value suitable?	Set the VD value.
	Does not the patient small pupil?	Make sure by measuring pupil diameter. When the pupil diameter is less than $\phi 2.3$ mm, the measurement result is not displayed.

Nothing prints.	Is the printer switched on?	If the printer switched off, nothing prints. Power on.
	Are you using the designated print roll?	Use the designated print roll.
	Is the paper holder cover open?	Close the paper holder cover.
	Is the paper roll inserted upside down?	Set the print roll correctly. See "7-2 Replacing the Print Roll".
	Is the printer set to output?	The printer is possibly not set to printout. Make sure the setting. See "5-2 OUTPUT Screen [OUTPUT]".

●Error message

If the following message is displayed and repeated again even after the equipment is turned off and on again, shut off the equipment and contact the dealer where you purchased the equipment.

Message	Cause
FOG ERROR	Initialization time of the fogging doesn't finish in time. Malfunction of the fog motor and breaking of wire.
MEMORY ERROR	Error in the backup memory.
LOW BATTERY	The error of clock function (RTC). The built-in battery (Lithium primary battery) is exhausted.

8-2 Station

Phenomenon	Check point	Cause and action
The charge lamp flashes during charging.	Long (Flashes lights 3 sec, off 0.5 sec)	Preservation function works when the battery thermal has increased or decreased. Check the temperature in the room (10°C to 35 °C). When the temperature decreased (10°C to 35 °C), restarts charging.
	Short (Flashes each of 0.5 sec)	Re-connect the main unit or printer regarding flow following. If you considered it were defect, contact to the dealer.

●Check Flashing of the Charging Lamp

The case that charging lamp flashes while it charging, defective of charging is considered.

The procedure to make sure following:

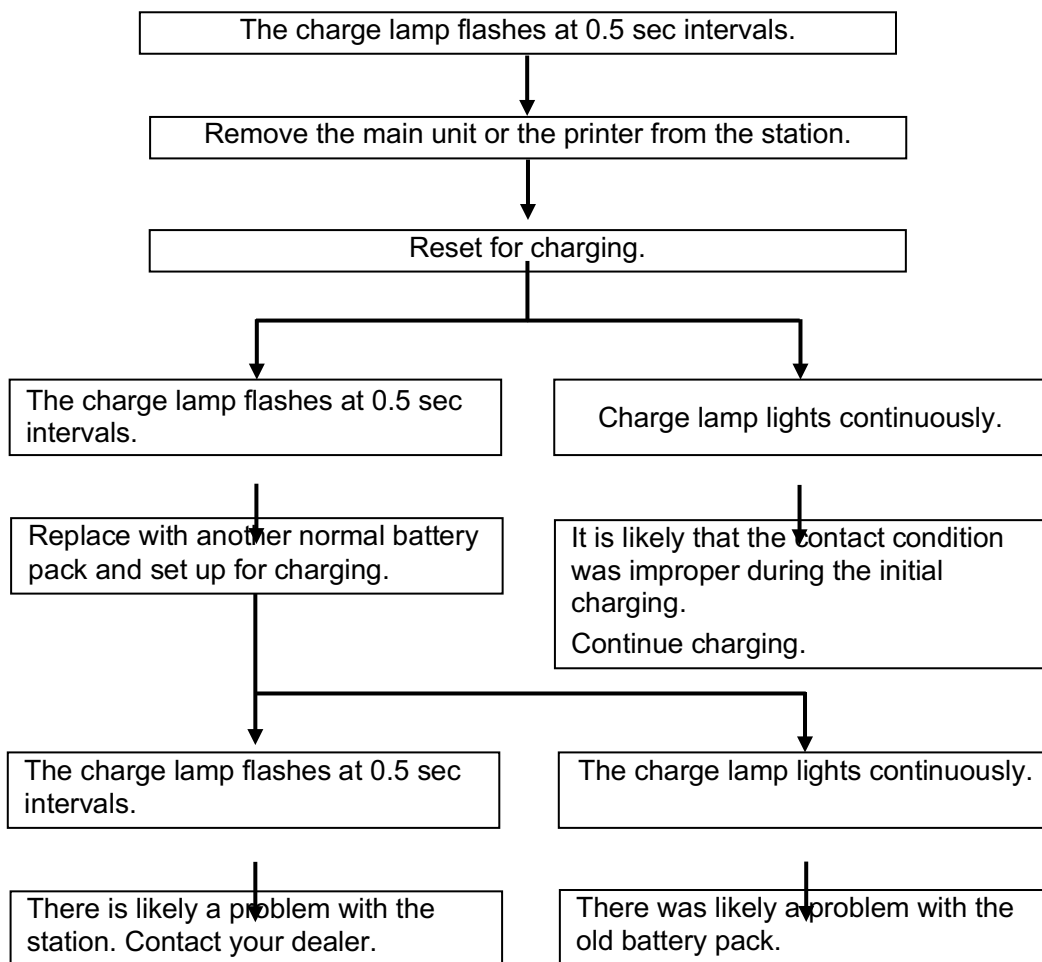

8-3 Printer

Phenomenon	Check point	Cause and action
The printer connected to the station does not turn on when the printer power switch is flipped on.	Is the printer correctly connected to the station?	Correct the connection. See "3-4-2 Automatic Charging of the Printer".
	Is the contact (5 places) dirty?	If touching the contacts (5 places) or getting dirty, wipe it off with a dry cloth.
	Is the station in a power-off state?	The printer will not operate if the station is not turned on. Turn on the station.
The battery pack is set in the printer, but the power lamp does not light when the power switch is set to on.	Is the battery pack in the correct orientation?	Check that the battery pack is correctly installed. See "3-2 Installing and Removing the Battery Pack".
	Is the lamp disappeared after 5 sec when it blinked with orange?	Recharge the battery pack. See "3-4 Charging the Battery Pack".
When the printer power lamp flashed pink color	Is the paper holder cover open?	Close the paper holder cover.
	Is the print roll set correctly?	Set the print roll correctly. See "7-2 Replacing the Print Roll".
	Was the measurement data printed when it transmitting? Or, was it transferred to computer?	Confront instrument transmission window with the printer's receiving window and transfer again.
The printer does not receive measurement data sent from the main unit.	Are there any obstacles between the main unit and printer?	Remove the obstacles, or move to a location free of obstacles.
	Is the printer too far away from the main unit?	Data can be transmitted to a location within 6 meters from the printer and with an angle of less than 45 degrees between the front side of the main unit and the light receiving window of the printer. And, if the mode were "CONT" or "Transmitting from Memory function", it cannot transfer over range of 50cm. See "4-5-1 Printing Procedure".
	Is the ID number of the printer same as that of the main unit?	Match the ID numbers by checking the OUTPUT screen and the DIP switch in the printer. See "4-5-4 Using Multiple Printers".
Characters are crowded on the print paper. The paper does not come out properly.	Is the print roll set correctly?	Set the print roll correctly. See "7-2 Replacing the Print Roll".
	Are there red lines on the edges of the print paper?	Replace the print roll. See "7-2 Replacing the Print Roll".
Cannot connect to external devices.	Is the communication setting of this unit and the external device correct?	Make sure the setting of each devices. See "6. Connecting to External Instruments".
Cannot send the data to RV-II.	Are there anything to interfere the connection between devices? (The case that connecting with IR to the RV-II.)	Make sure there are nothing to interfere the communication.

- Built in Battery

This instrument houses a lithium primary battery. If the battery exhausted, the date & time varies. If the display as shown in the figure following appears, please contact to the dealer where you purchased the equipment.

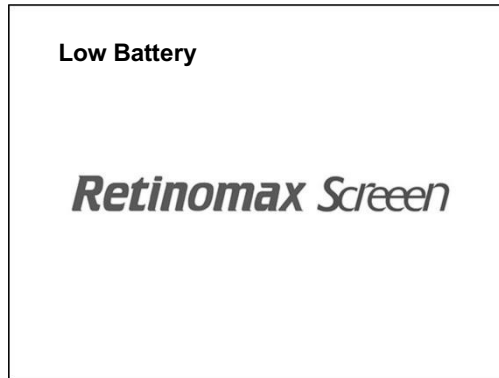

Display if Built-in Battery exhausted

9. Main Specifications

<Name> Hand Held Auto refractometer
Retinomax Screen

<Measurement Function>

▼ Refractive measurement

Measurement range S+C: -20D to +23D(VD=12)
C : 0D to ±12D
A : 0° to 180°
Measurement step S,C : AUTO (±3D : 0.12/or the other is 0.25)/0.12/0.25
A : 1°
Min. pupil size φ2.3mm
Measurement wavelength 840nm to 900nm
Corneal vertex distance 12/13.5/13.75/15/16/0

▼ Pupil size measurement

Measurement range 2.0mm to 12.0mm
Measurement step 0.1mm

<Other Functions>

- ▼ Automatic right/ left eye detector
- ▼ Alignment direction indication
- ▼ Focus assist function
- ▼ Automatic astigmatism axis correction function
- ▼ Auto Quick
- ▼ Auto fixation chart brightness switching
- ▼ Power saving function
- ▼ CHILD mode
- ▼ Retroillumination mode
- ▼ Memory function
- ▼ Astigmatism axis rotation function
- ▼ Continuous measurement mode

<Measurement Time>

Ref only measurement(from display to display) 0.124 sec

<Other>

▼ Main body

Main body dimension	W168mm×D202mm×H236mm
Weight	960g (With battery) 860g (Without battery)
Power source	Charging DC8.4V / 1.3A
Real time clock	Built-in real time clock for printing of year/month/day/time/minute
Monitor	3.5 inch color LCD QVGA
External output	Communication to Retinomax Printer 5 via Infrared (max.6m)
Fixation chart	Tulip, Bear, Firework (factory option)
Fixation chart lighting	2 level adjustable luminance
Alignment target	18 point dot LED, ϕ 2.6mm (at R8mm)

MAIN LED peak central wavelength	870nm
Strength of emission	$2.29\mu\text{W}/\text{cm}^2$

Spectrum output of all light source during measurement

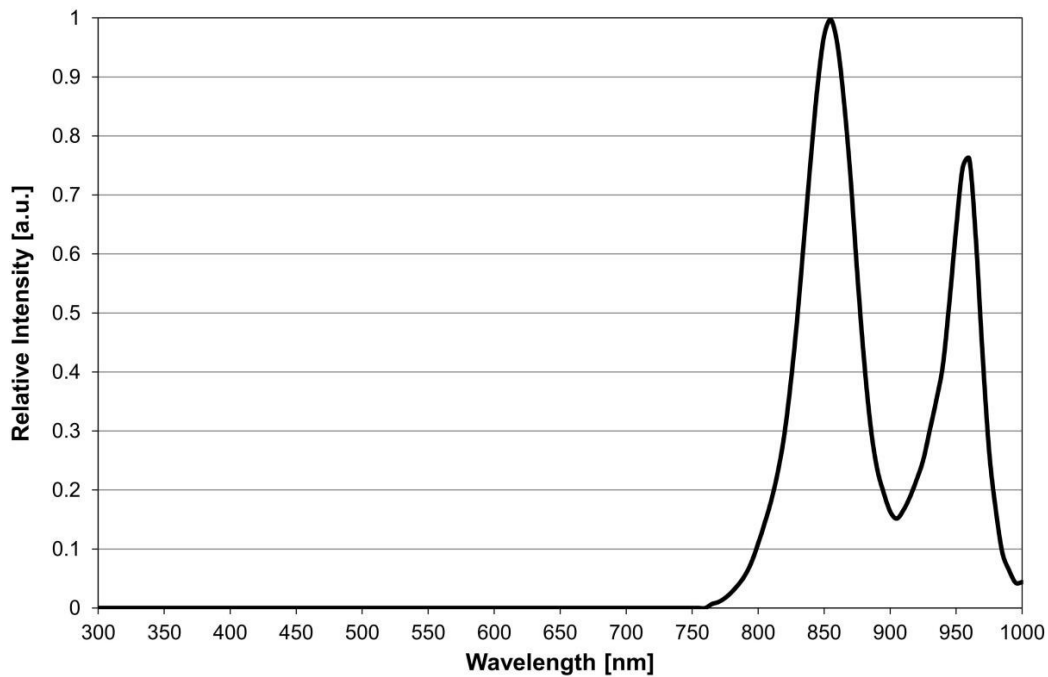

▼ **Station**

Dimensions	W 180mm×D 244mm×H 79mm
Weight	790g
Input power	100—240V 50/60Hz (No voltage switch)
Power consumption	Max. 70VA
Charging battery	Auto
Charging time	3 hours

▼ **Printer**

Dimension	W 103mm×D 167mm×H 75mm
Weight	450g (With battery) 350g (Without battery)
Print paper width	58mm
Drive	Powered from the station (when docked with the station) Battery drive (when separated from the station and a battery pack is installed.) USB supply from the computer (when separated from the station and without battery) *Only data communication.
Power source	Input: DC8.8V 2.0A Charging: DC8.4V 1.3A USB: DC5.0V 30mA
Input	IR communication
Output	USB

▼ **Battery pack**

Battery	Lithium ion battery RT-01XR
Nominal voltage	DC7.2V
Nominal capacity	2500mAh
Weight	Approx. 100g
Dimensions	W 37.6mm×D 71.6mm×H 20.3mm

CE0459